







More Precision

indu**SENSOR** // Linear inductive displacement sensors





-  **Proven LVDT technology**
-  **Measuring ranges $\pm 1 \dots \pm 10$ mm**
-  **Low cost especially with a large number of pieces**
-  **Sensor diameter of just $\varnothing 8$ mm**
-  **Models with pneumatic push**

LVDT gauge sensors DTA-xG8 are primarily used for the measurement and inspection of workpiece geometry (e.g. length, width, diameter, thickness, depth, height). Therefore, different measuring ranges from ± 1 mm to ± 10 mm are available. The gauges are particularly suitable for applications involving a large number of pieces.

These gauges have an axial cable outlet and are equipped with either a plain bearing-guided plunger and a return spring, or with a pneumatic push rod. Depending on the measuring object, different probe tips are available.

DTA gauges can be operated with every MSC controller. Depending on this controller, single-/dual-/multi-channel measurements are possible. In addition to the well-established analog output, modern fieldbuses are available for integration purposes.

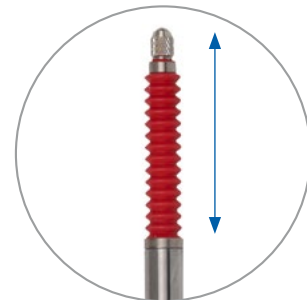

Plunger with return spring



Based on modern interfaces and multi-channel capability, the MSC controllers open up new fields of application.

Article designation

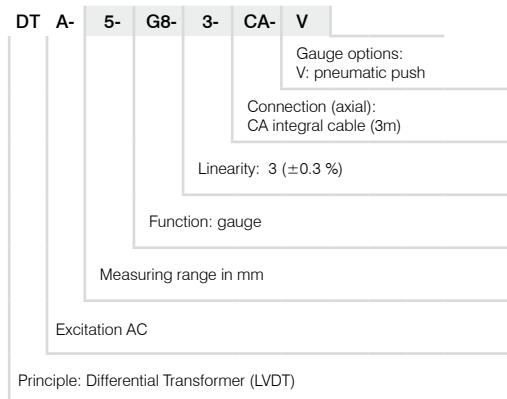

Model	DTA-1G8	DTA-3G8	DTA-5G8	DTA-10G8	DTA-1G8-V	DTA-3G8-V	DTA-5G8-V	DTA-10G8-V
Measuring range	±1 mm	±3 mm	±5 mm	±10 mm	±1 mm	±3 mm	±5 mm	±10 mm
Linearity	≤ ±6 μm	≤ ±18 μm	≤ ±30 μm	≤ ±60 μm	≤ ±6 μm	≤ ±18 μm	≤ ±30 μm	≤ ±60 μm
Repeatability ¹⁾	≤0.15 μm	≤0.45 μm	≤0.75 μm	≤1.5 μm	≤0.15 μm	≤0.45 μm	≤0.75 μm	≤1.5 μm
Temperature stability	≤ 250 ppm FSO/K							
Sensitivity	133 mV / mm/V	85 mV / mm/V	53 mV / mm/V	44 mV / mm/V	133 mV / mm/V	85 mV / mm/V	53 mV / mm/V	44 mV / mm/V
Excitation frequency	5 kHz	5 kHz	5 kHz	2 kHz	5 kHz	5 kHz	5 kHz	2 kHz
Excitation voltage	550 mV							
Connection	integrated cable (3 m) with open ends; axial cable outlet; drag-chain suitable; cable diameter of 3.1 mm; min. bending radii: fixed installation 25 mm, moving 38 mm, drag chain 47 mm							
Temperature range	-40 ... +80 °C							
Storage	-40 ... +80 °C							
Operation	-20 ... +80 °C (without bellows); 0 ... 80 °C (with bellows)							
Pressure resistance	atmospheric pressure							
Shock (DIN EN 60068-2-27)	40 g / 6 ms in 3 axes, 1000 shocks each							
Vibration (DIN EN 60068-2-6)	±1.5 mm / 10 ... 58 Hz in 2 axes, 10 cycles each ±20 g / 58 ... 500 Hz in 2 axes, 10 cycles each							
Protection class (DIN EN 60529)	IP65 (with bellows); IP54 (without bellows)							
Material	Stainless steel (housing); FPM (bellows); PUR (cable sheath); PVC/PP (cable braids)							
Weight	approx. 70 g	approx. 70 g	approx. 75 g	approx. 85 g	approx. 70 g	approx. 70 g	approx. 80 g	approx. 85 g
Typical spring forces ²⁾	SMR 1.3 N	0.8 N	1 N	0.7 N	depending on air pressure			
	MMR 1.55 N	1.5 N	1.9 N	1.9 N				
	EMR 2 N	2.5 N	3 N	3.5 N				
Compatibility	MSC7401, MSC7802, MSC7602							
Typ. service life	5 million cycles							

FSO = Full Scale Output

SMR = Start of measuring range, MMR = Mid of measuring range, EMR = End of measuring range

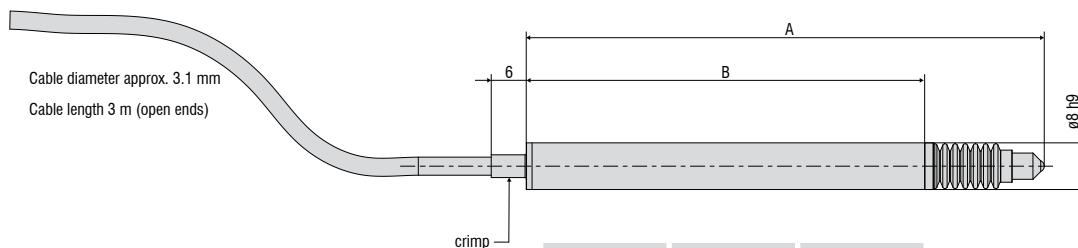
¹⁾ Averaging over 100 values; 200 repetitions²⁾ Removing the bellows changes the spring forces**DTA-xG8-3-CA**

Model	A (zero position)	B
DTA-1G8-3-CA	82.8 mm	64.3 mm
DTA-3G8-3-CA	88.2 mm	68.3 mm
DTA-5G8-3-CA	118.0 mm	89.5 mm
DTA-10G8-3-CA	155.0 mm	121.7 mm

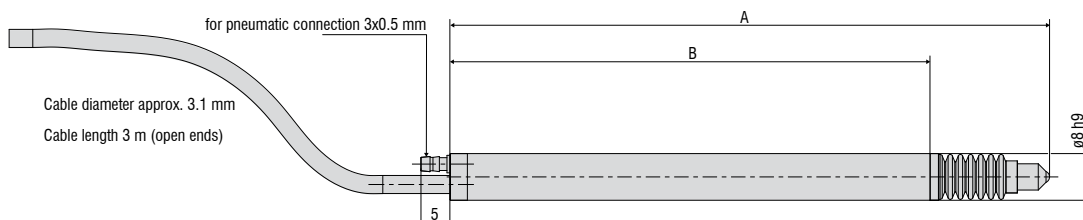
DTA-xG8-3-CA-V

Modell	A (zero position)	B
DTA-1G8-3-CA-V	94.8 mm	76.3 mm
DTA-3G8-3-CA-V	102.8 mm	82.3 mm
DTA-5G8-3-CA-V	134.0 mm	105.3 mm
DTA-10G8-3-CA-V	171.0 mm	137.3 mm

Dimensions in mm, not to scale

Sensor cables

- C701-3 Sensor cable, 3 m, with cable connector and tin-plated free ends
- C701-6 Sensor cable, 6 m, with cable connector and tin-plated free ends
- C701/90-3 Sensor cable, 3 m, with 90° cable connector and tin-plated free ends
- IF7001 Single-channel USB/RS485 converter for MSC7xxx

Service

- Assembly of screw flange - DTA-xG8
- Connector assembly M9 and cable reduction XXXX mm - DTA-x
- Connector assembly M9 - DTA-x

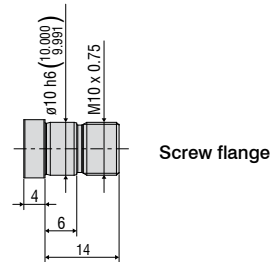

Probe tips

- Type 2 probe tip / hard metal
- Type 2 probe tip / plastics
- Type 2 probe tip / ruby
- Type 2 probe tip / steel
- Type 10 probe tip / steel
- Type 11 probe tip / steel
- Type 13 probe tip / steel

Standard probe tip: type 2

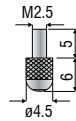

Option: type 10

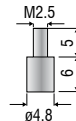

Option: type 11



Option: type 13

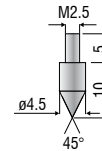

Sensor mounting

- MBS12/8 Mounting block Sensor mounting for circumferential clamping
- MBS12/8 Adapter ring for reduction to D8 (gauge)

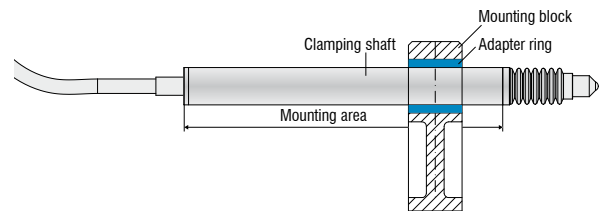

Mounting block MBS12/8

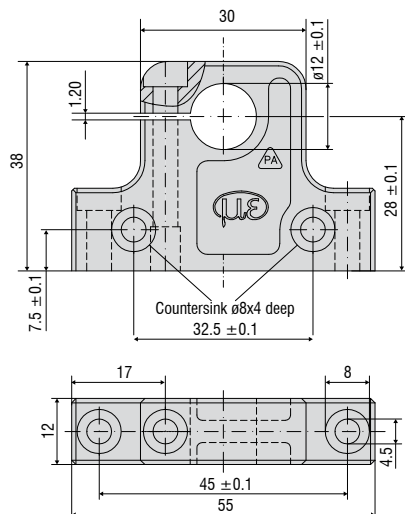

Adapter ring

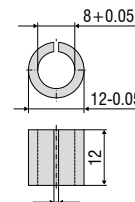

Gauges from Micro-Epsilon have many possible fields of application. Due to different measuring ranges and configuration settings, the gauges are suitable for numerous measurement and inspection tasks. Combined with multi-channel controllers, the DTA gauges are often used for dimensional measurement and inspection tasks, e.g., in automated quality control, R&D and production monitoring.

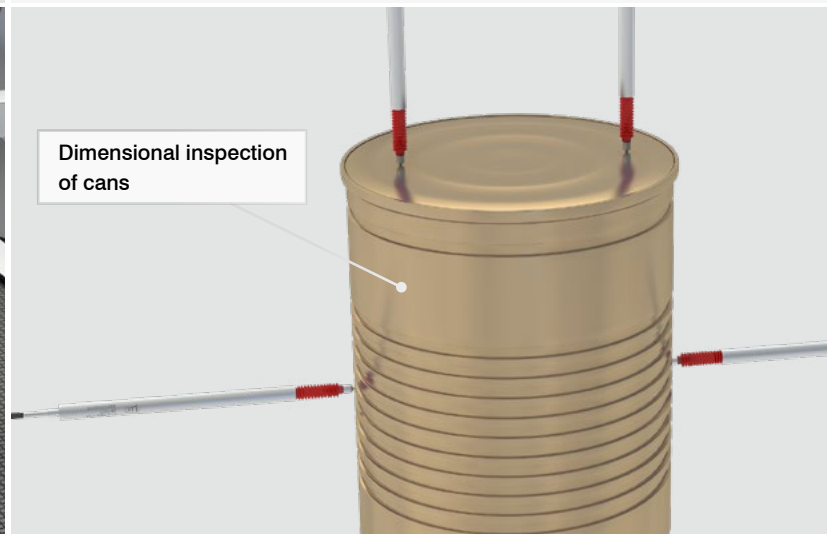
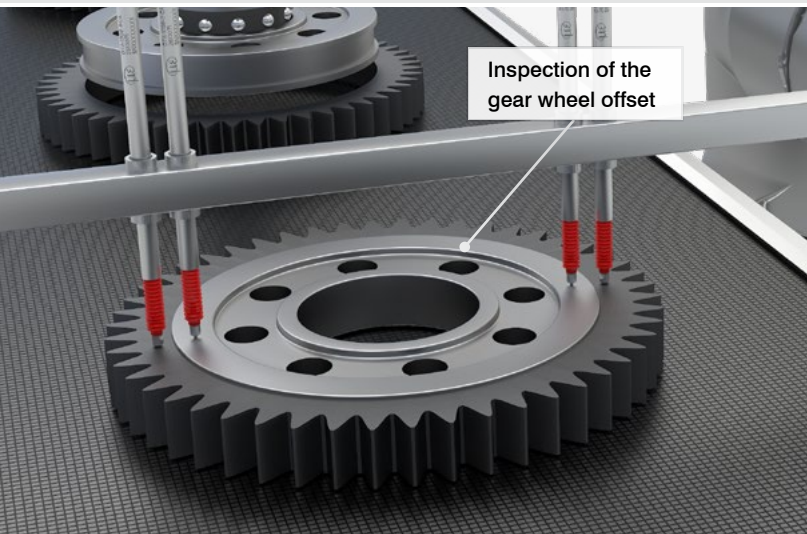
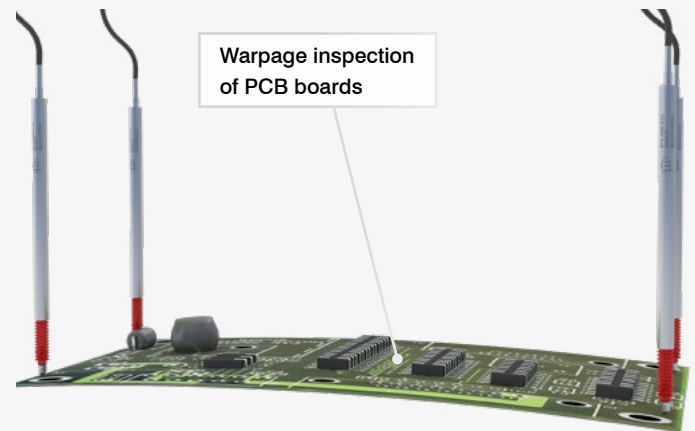
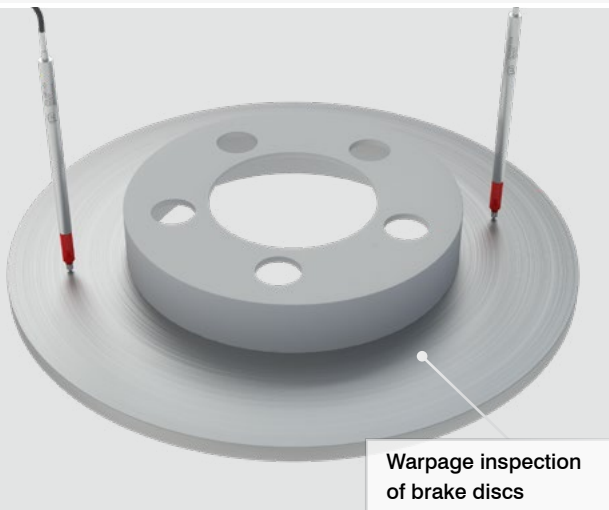
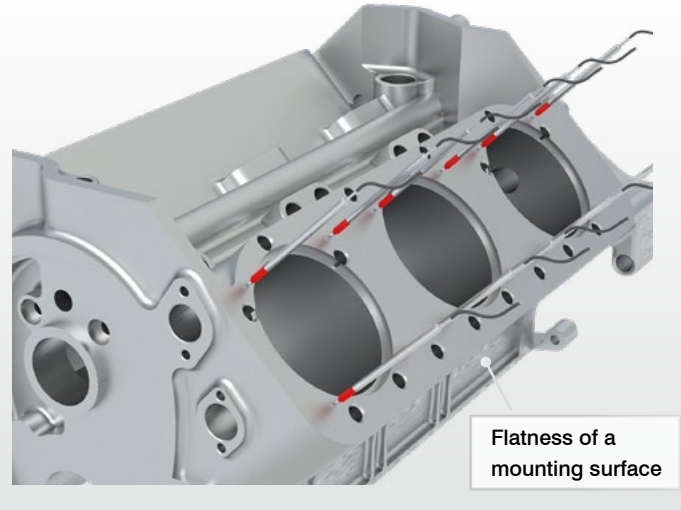

Sensors and Systems from Micro-Epsilon

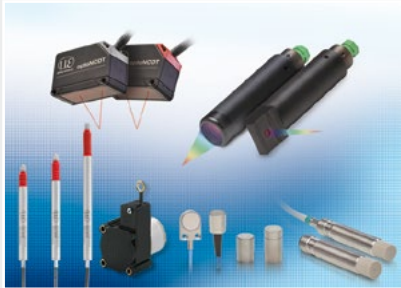

Sensors and systems for displacement, distance and position



Sensors and measurement devices for non-contact temperature measurement



Measuring and inspection systems for metal strips, plastics and rubber



Optical micrometers and fiber optics, measuring and test amplifiers



Color recognition sensors, LED analyzers and inline color spectrometers



3D measurement technology for dimensional testing and surface inspection