









More Precision

interferoMETER // Ultra-precise white light interferometers



Absolute distance measurement with nanometer resolution

interferoMETER 5400-DS

-  Absolute measurement with nanometer resolution
-  Compact and robust sensors with large offset distance
-  Measuring rate up to 6 kHz for high speed measurements
-  Ethernet / EtherCAT / RS422 / PROFINET / EtherNet/IP
-  Robust controller with passive cooling
-  Easy configuration via web interface



Absolute distance measurements with nanometer resolution

The IMS5400-DS white light interferometer opens up new perspectives in industrial distance measurement. The controller has an intelligent evaluation feature and enables absolute measurements with nanometer resolution at a relatively large offset distance. Compared to other absolute measuring optical systems, the IMS5400-DS offers an unsurpassed combination of accuracy, measuring range and offset distance.

Small light spot for the smallest of details and structures

The sensors generate a small light spot over the entire measuring range. The light spot diameter is only 10 μm and allows the detection of small details such as structures on semiconductors and miniature electronic components.

Absolute measurement of step profiles

Unlike interferometers based on relative measurements, the IMS5400-DS also enables the measurement of step profiles. Thanks to the absolute measurement, the scanning is performed with high signal stability and precision. When measuring on moving objects, the differences in height of heels, steps and depressions can thus be reliably detected.

Multi-peak distance measurement

With multi-peak distance measurement on transparent objects, up to 14 distance values can be evaluated. For example, the distance between the glass and the mask can be determined. If required, the controller can calculate the glass thickness based on the peaks.

 **14 distance values in a measuring range of 2.1 mm**

Multi-peak distance measurement

With multi-peak distance measurement, up to 14 distance values can be evaluated. This allows the distance between the glass and the mask to be determined.



Due to their extremely compact size, these sensors can also be integrated into restricted spaces.

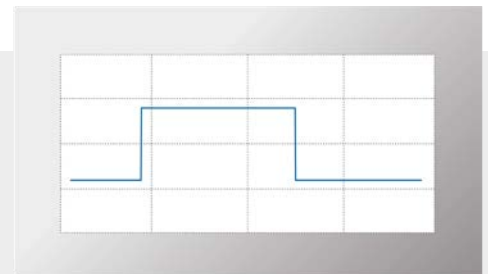

Absolute measurement of step profiles

Due to the absolute thickness measurement, step profiles are detected with high signal stability and subnanometer resolution.

Model		IMS5400-DS19	IMS5400MP-DS19
Measuring range	Distance	2.1 mm	
	Thickness	-	0.010 ... 1.3 mm with BK7
Start of measuring range		approx. 19 mm	
Resolution ¹⁾		< 1 nm	
Measuring rate		continuously adjustable from 100 Hz to 6 kHz	
Linearity ²⁾		< ±50 nm	< ±50 nm for the first distance < ±150 nm for each further distance
Temperature stability	Sensor	Linearity: typ. 0.1 nm / K (without offset displacement)	
	Controller	temperature compensated, stability < 10 ppm between +15 ... +35 °C	
Multi-layer measurement		-	up to 13 layers
Light source		NIR-SLED, wavelength 840 nm Pilot laser: laser LED, wavelength 635 nm	
Laser class		Class 1 according to DIN EN 60825-1: 2015-07 Pilot laser: Class 1, power (< 0.2 mW)	
Light spot diameter ³⁾		10 µm	
Measuring angle ⁴⁾		±2°	
Target material		Glass, reflecting or diffuse surfaces ⁵⁾	
Supply voltage		24 VDC ±15 %	
Power consumption		approx. 10 W (24 V)	
Signal input		Sync in, trigger in, 2x encoders (A+, A-, B+, B-, index)	
Digital interface		Ethernet / EtherCAT / RS422 / PROFINET ⁶⁾ / EtherNet/IP ⁶⁾	
Analog output		4 ... 20 mA / 0 ... 10 V (16 bit D/A converter)	
Switching output		Error1-Out, Error2-Out	
Digital output		sync out	
Connection	Optical	pluggable optical fiber via E2000 socket (controller) and FC socket (sensor); standard length 3 m, 5 m and 10 m; other cable lengths on request; bending radius: static 30 mm, dynamic 40 mm	
	Electrical	3-pin supply terminal strip; encoder connection (15-pin, HD-sub socket, max. cable length 3 m, 30 m with external encoder supply); RS422 connection socket (9-pin, Sub-D, max. cable length 30 m); 3-pin output terminal strip (max. cable length 30 m); 11-pin I/O terminal strip (max. cable length 30 m); RJ45 socket for Ethernet (out) / EtherCAT (in/out) (max. cable length 100 m)	
Mounting	Sensor	Clamping, mounting adapter (see accessories)	
	Controller	free-standing, DIN rail mounting	
Temperature range	Storage	-20 ... +70 °C	
	Operation	Sensor: +5 ... +70 °C; Controller: +15 ... +35 °C	
Shock (DIN EN 60068-2-27)		15 g / 6 ms in XY axis, 1000 shocks each	
Vibration (DIN EN 60068-2-6)		2 g / 20 ... 500 Hz in XY axis, 10 cycles each	
Protection class (DIN EN 60529)	Sensor	IP65 IP40 (option / VAC)	
	Controller	IP40	
Vacuum		Optional UHV (cable and sensor)	
Material	Sensor	Stainless steel	
	Controller	Aluminum housing, passive cooling	
Control and indicator elements		Multifunction button: two adjustable functions and reset to factory settings after 10 s; web interface for setup: selectable presets, freely selectable averaging, data reduction, setup management; 6 x color LEDs for intensity, range, SLED, pilot laser, status and power; pilot laser: can be switched on for sensor alignment	

All data at constant ambient temperature (24 ± 2 °C)

¹⁾ Measuring rate 0.5 kHz, moving average over 64 values, measured differentially between the front and back of a thin glass plate in the mid of the measuring range (2 sigma)

²⁾ Maximum deviation from reference system over the entire measuring range, measured on front surface of ND filter

³⁾ In the mid of the measuring range

⁴⁾ Maximum sensor tilt angle that produces a usable signal on polished glass (n = 1.5) in the mid of the measuring range.

The accuracy decreases when approaching the limit values.

⁵⁾ Non-transparent materials require optically dense surface at a wavelength of 840 nm

⁶⁾ Optional connection via interface module (see accessories)

Dimensions interferoMETER

IMS5400-DS sensor

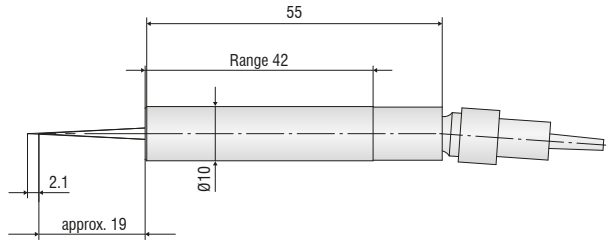

IMS5400-TH45 sensor

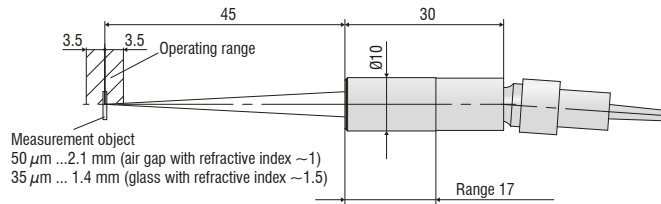

IMS5400-TH70 sensor

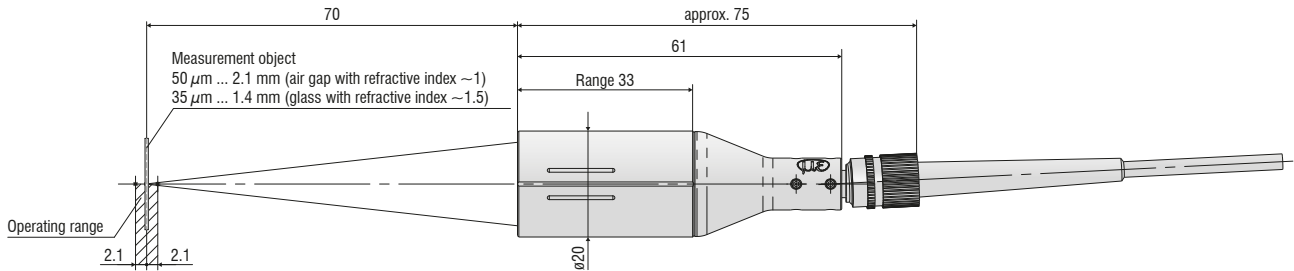

IMS5400-DS / IMS5400-TH / IMS5600-DS controllers

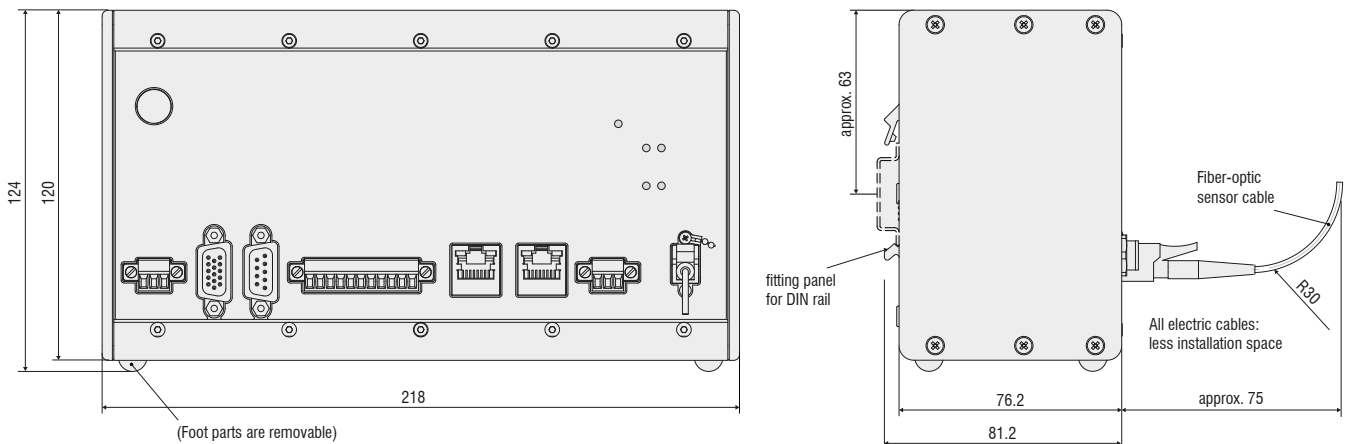

Accessories

interferoMETER

Cables

Standard E2000/APC (controller) and FC/APC connector (sensor)

C5401-2	Optical fiber, length 2 m
C5401-3	Optical fiber, length 3 m
C5401-5	Optical fiber, length 5 m
C5401-10	Optical fiber, length 10 m
Other lengths up to 20 m on request	

Drag chain E2000/APC (controller) and FC/APC connector (sensor)

C5401-3(010)	Optical fiber, length 3 m
C5401-5(010)	Optical fiber, length 5 m
C5401-10(010)	Optical fiber, length 10 m
Other lengths up to 20 m on request	

Vacuum cable FC/APC connector

C5400-1/VAC	Optical fiber, length 1 m
C5400-2/VAC	Optical fiber, length 2 m
C5400-5/VAC	Optical fiber, length 5 m

Flange for vacuum feed through

C5405/VAC/1/CF16	CF flange
C5405/VAC/1/KF16	KF flange

Mounting Adapter

MA5400- 10	Mounting adapter for IMP-DS19/ -TH45
MA5400- 20	Mounting adapter for IMP-TH70

Other accessories

SC2471-x/IF2008	IMC5400/5600 connector cable+ IF2008/PCIE, length 3 m / 10 m
SC2471-x/RS422/OE	IMC5400/5600 interface cable + IF2001/USB, length 3 m / 10 m
IF2001/USB	RS422/USB converter
IF2008/PCIE	Interface card
IF2030/PNET	Interface module for PROFINET integration
PS2020	Power supply 24V / 2.5A
EC2471-3/OE	Encoder cable, 3 m

E2000/APC standard connector

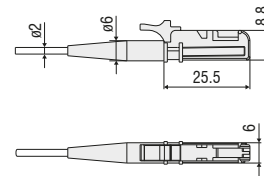

FC/APC standard connector

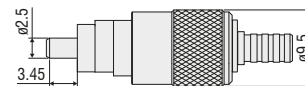

C5405/VAC/1/CF16
C5405/VAC/1/KF16

Accessories interferoMETER

Sensor mounting adapter

For DS19/TH45:
MA5400-10

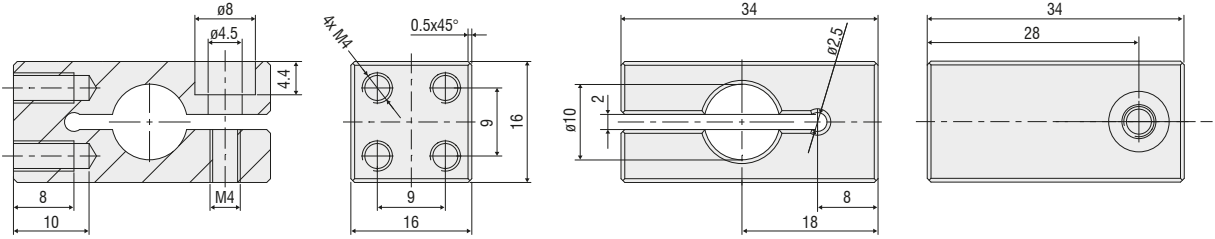

For TH70:
MA5400-20

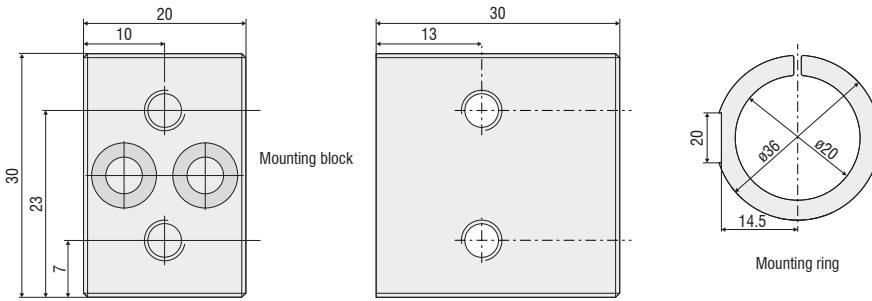

(dimensions in mm, not to scale)

Adjustable mounting adapter

The adjustable JMA mounting adapter simplifies the alignment and fine adjustment of interferometric sensors. You can integrate the sensors with the adapter directly into the machine and then align them directly on site. This corrects, e.g. minor deviations caused by mounting and compensates for tilted measuring objects. With two-sided thickness measurements, the mounting adapter supports the fine alignment of the two measuring points.

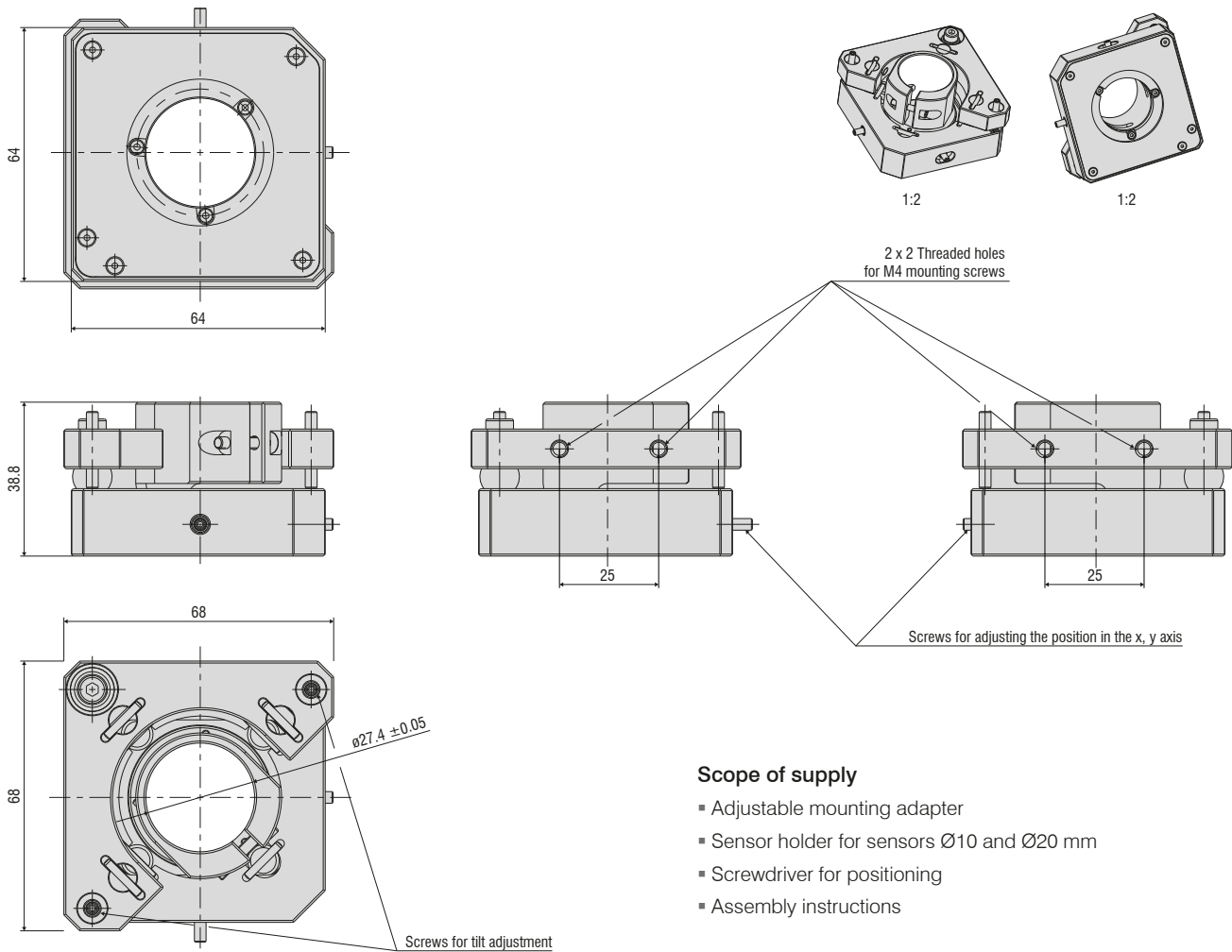

Scope of supply

- Adjustable mounting adapter
- Sensor holder for sensors $\varnothing 10$ and $\varnothing 20$ mm
- Screwdriver for positioning
- Assembly instructions

Sensor holder

Sensor holder for JMA-10

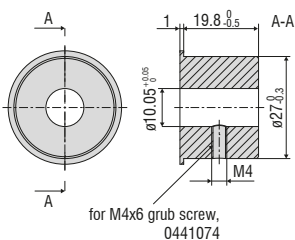

Sensor holder for JMA-20

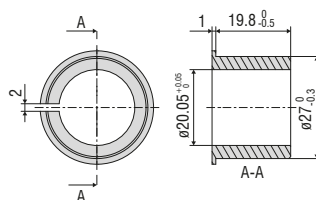

Sensors and Systems from Micro-Epsilon



Sensors and systems for displacement, distance and position



Sensors and measurement devices for non-contact temperature measurement



Measuring and inspection systems for metal strips, plastics and rubber



Optical micrometers and fiber optics, measuring and test amplifiers



Color recognition sensors, LED analyzers and inline color spectrometers



3D measurement technology for dimensional testing and surface inspection