







More Precision

interferoMETER // Ultra-precise white light interferometers



Stable thickness measurement with submicrometer resolution

interferoMETER 5400-TH

-  Nanometer-accurate thickness measurement even with varying distances
-  Stable measurement from a long distance
-  Precise thickness measurement of up to 5 layers
-  Measuring rate up to 6 kHz for high speed measurements
-  **INTERFACE** Ethernet / EtherCAT / RS422 / PROFINET / EtherNet/IP



Stable thickness measurement with varying distances

The IMS5400-TH white light interferometer opens up new perspectives in industrial thickness measurement. The interferometer is used for highly accurate thickness measurements from a relatively large distance. The large thickness measuring range allows the measurement of thin layers, flat glass and films. Since the white light interferometer works with an SLED in the near infrared range, it is possible to measure the thickness of optically non-dense objects such as anti-reflective coated glass.

Reliable even with fluttering material

A decisive advantage is the distance-independent measurement, where a stable nanometer-accurate thickness value is achieved. This is how the target can move within the measuring range without influencing the accuracy.

Multi-layer thickness measurement

The thickness of transparent coated objects or laminated glass can be reliably measured thanks to the multi-layer thickness measurement. The controller outputs the thickness values with the highest stability regardless of their position.

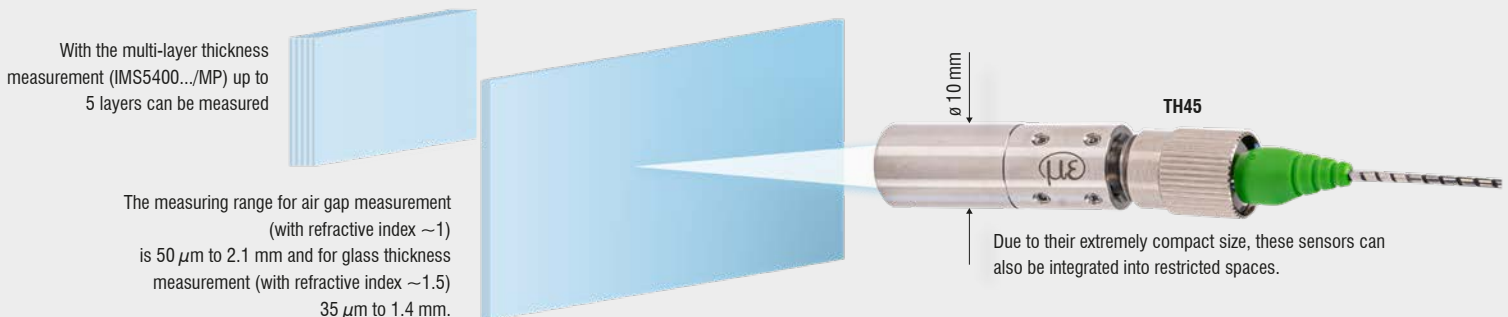

Model	IMS5400-TH45	IMS5400MP-TH45	IMS5400-TH70	IMS5400MP-TH70
Working distance	45 mm ±3.5 mm	45 mm ±3.5 mm	70 mm ±2.1 mm	70 mm ±2.1 mm
Measuring range (thickness)	0.035 ... 1.4 mm ¹⁾			
Resolution ²⁾	< 1 nm			
Measuring rate	continuously adjustable from 100 Hz to 6 kHz			
Linearity ³⁾	< ±100 nm	< ±100 nm	< ±200 nm	< ±200 nm
Temperature stability	Sensor	Linearity valid for the entire temperature range		
	Controller	temperature compensated, stability < 10 ppm between +15 ... +35 °C		
Multi-layer measurement	1 layer	up to 5 layers	1 layer	up to 5 layers
Light source	NIR-SLED, wavelength 840 nm Pilot laser: laser LED, wavelength 635 nm			
Laser class	Class 1 according to DIN-EN 60825-1: 2015-07 Pilot laser: Class 1, power (< 0.2 mW)			
Light spot diameter ⁴⁾	10 μm	10 μm	5 μm	5 μm
Measuring angle ⁵⁾	±2°	±2°	±4°	±4°
Supply voltage	24 VDC ±15 %			
Power consumption	approx. 10 W (24 V)			
Signal input	Sync in, trigger in, 2x encoders (A+, A-, B+, B-, index)			
Digital interface	Ethernet / EtherCAT / RS422 / PROFINET ⁶⁾ / EtherNet/IP ⁶⁾			
Analog output	4 ... 20 mA / 0 ... 10 V (16 bit D/A converter)			
Switching output	Error1-Out, Error2-Out			
Digital output	sync out			
Connection	Optical	pluggable optical fiber via E2000 socket (controller) and FC socket (sensor); standard length 3 m, 5 m and 10 m; other cable lengths on request; bending radius: static 30 mm, dynamic 40 mm		
	Electrical	3-pin supply terminal strip; encoder connection (15-pin, HD-sub socket, max. cable length 3 m, 30 m with external encoder supply); RS422 connection socket (9-pin, Sub-D, max. cable length 30 m); 3-pin output terminal strip (max. cable length 30 m); 11-pin I/O terminal strip (max. cable length 30 m); RJ45 socket for Ethernet (out) / EtherCAT (in/out) (max. cable length 100 m)		
Mounting	Sensor	Clamping, mounting adapter (see accessories)		
	Controller	free-standing, DIN rail mounting		
Temperature range	Storage	-20 ... +70°C		
	Operation	Sensor: +5 ... +70 °C; Controller: +15 ... +35 °C		
Shock (DIN EN 60068-2-27)	15 g / 6 ms in XY axis, 1000 shocks each			
Vibration (DIN EN 60068-2-6)	2 g / 20 ... 500 Hz in XY axis, 10 cycles each			
Protection class (DIN EN 60529)	Sensor	IP65		-
	Controller	IP40 (option / VAC)		-
Vacuum	Optional UHV (cable and sensor)		-	
Material	Sensor	Stainless steel		
	Controller	Aluminum housing, passive cooling		
Control and indicator elements	Multifunction button: two adjustable functions as well as reset to factory settings after 10 s; web interface for setup: selectable presets, freely selectable averaging, data reduction, setup management; 6 x color LEDs for intensity, range, SLED, pilot laser, status and power; pilot laser: switchable for sensor alignment (laser LED 635 nm, laser class 1, power < 0.2 mW)			

All data at constant ambient temperature (24 ± 2 °C)

¹⁾ Measuring range with n=1.5; for air gap measurement between two glass plates (n~1) the measuring range is 0.05 ... 2.1 mm.

The measuring object must be within the working distance.

²⁾ Measuring rate 0.5 kHz, moving averaging over 64 values, measured on an approx. 1 mm thick BK7 optical flat (2 sigma)

³⁾ Maximum thickness deviation when measuring on an approx. 1 mm thick BK7 optical flat (n=1.5) when passing through the measuring range

⁴⁾ With a working distance of 45 mm (TH-45) or 70 mm (TH-70)

⁵⁾ Maximum sensor tilt angle that produces a usable signal on an approx. 0.6 mm thick BK7 optical flat in the mid of the measuring range.

The accuracy decreases when approaching the limit values.

⁶⁾ Optional connection via interface module (see accessories)

Dimensions interferoMETER

IMS5400-DS sensor

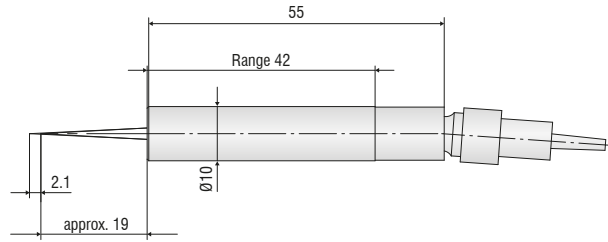

IMS5400-TH45 sensor

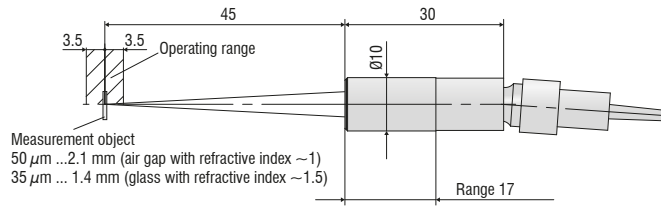

IMS5400-TH70 sensor

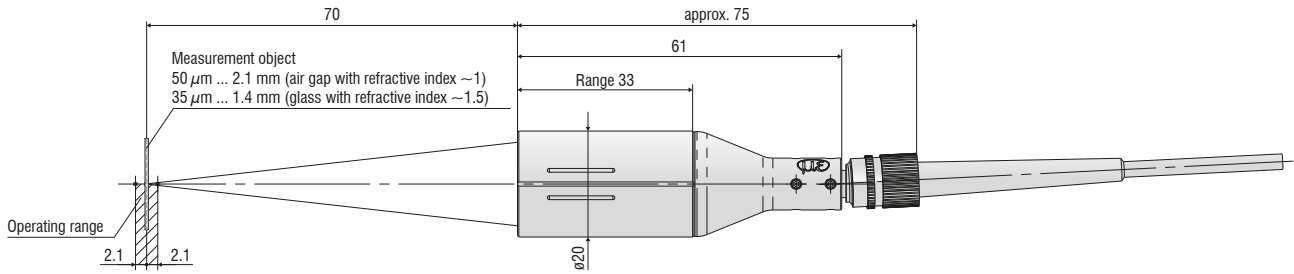

IMS5400-DS / IMS5400-TH / IMS5600-DS controllers

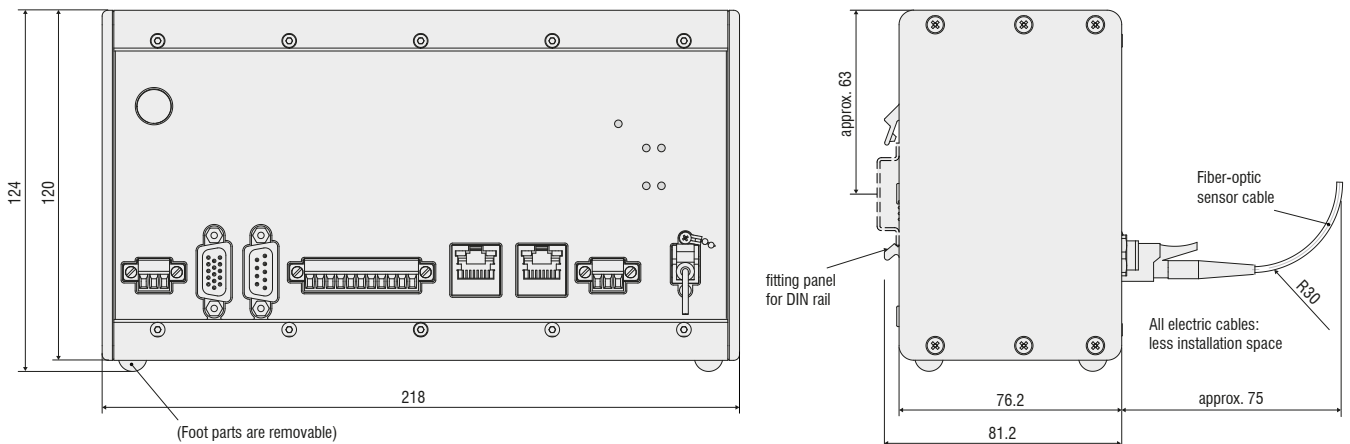

Accessories

interferoMETER

Cables

Standard E2000/APC (controller) and FC/APC connector (sensor)

C5401-2	Optical fiber, length 2 m
C5401-3	Optical fiber, length 3 m
C5401-5	Optical fiber, length 5 m
C5401-10	Optical fiber, length 10 m
Other lengths up to 20 m on request	

Drag chain E2000/APC (controller) and FC/APC connector (sensor)

C5401-3(010)	Optical fiber, length 3 m
C5401-5(010)	Optical fiber, length 5 m
C5401-10(010)	Optical fiber, length 10 m
Other lengths up to 20 m on request	

Vacuum cable FC/APC connector

C5400-1/VAC	Optical fiber, length 1 m
C5400-2/VAC	Optical fiber, length 2 m
C5400-5/VAC	Optical fiber, length 5 m

Flange for vacuum feed through

C5405/VAC/1/CF16	CF flange
C5405/VAC/1/KF16	KF flange

Mounting Adapter

MA5400- 10	Mounting adapter for IMP-DS19/ -TH45
MA5400- 20	Mounting adapter for IMP-TH70

Other accessories

SC2471-x/IF2008	IMC5400/5600 connector cable+ IF2008/PCIE, length 3 m / 10 m
SC2471-x/RS422/OE	IMC5400/5600 interface cable + IF2001/USB, length 3 m / 10 m
IF2001/USB	RS422/USB converter
IF2008/PCIE	Interface card
IF2030/PNET	Interface module for PROFINET integration
PS2020	Power supply 24V / 2.5A
EC2471-3/OE	Encoder cable, 3 m

E2000/APC standard connector

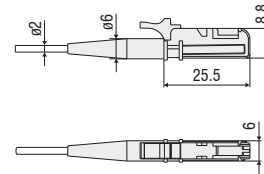

FC/APC standard connector

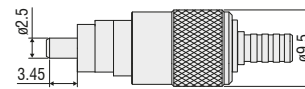

C5405/VAC/1/CF16
C5405/VAC/1/KF16

Accessories

interferoMETER

Sensor mounting adapter

For DS19/TH45:
MA5400-10

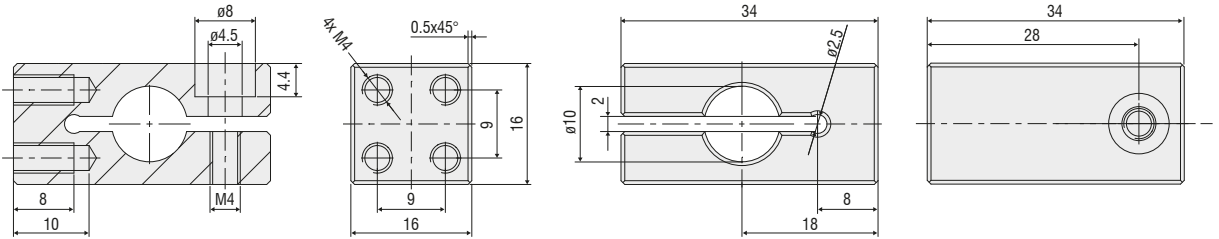

For TH70:
MA5400-20

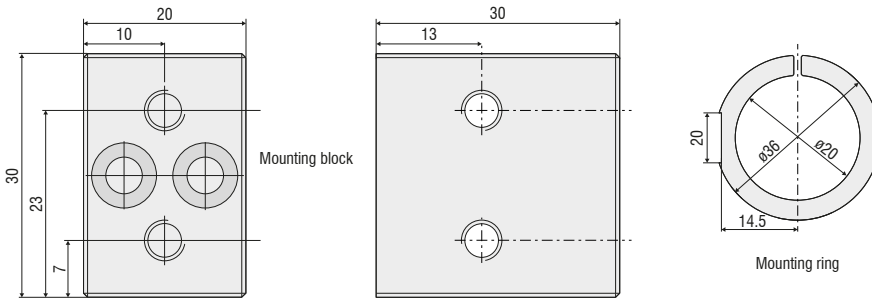

(dimensions in mm, not to scale)

Adjustable mounting adapter

The adjustable JMA mounting adapter simplifies the alignment and fine adjustment of interferometric sensors. You can integrate the sensors with the adapter directly into the machine and then align them directly on site. This corrects, e.g. minor deviations caused by mounting and compensates for tilted measuring objects. With two-sided thickness measurements, the mounting adapter supports the fine alignment of the two measuring points.

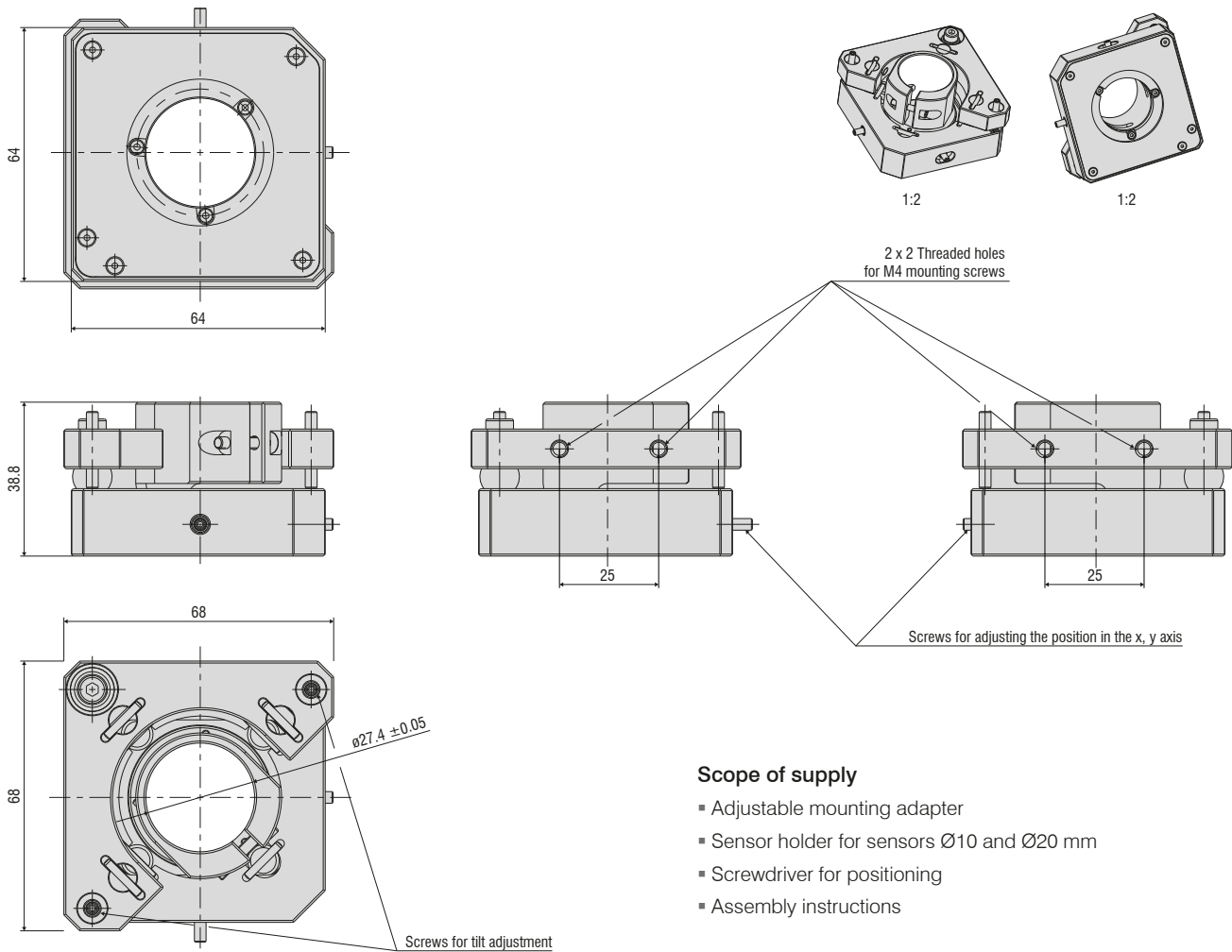

Sensor holder

Sensor holder for JMA-10

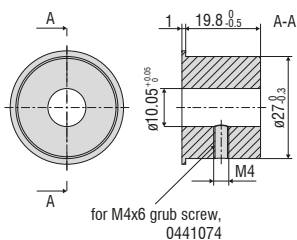

Sensor holder for JMA-20

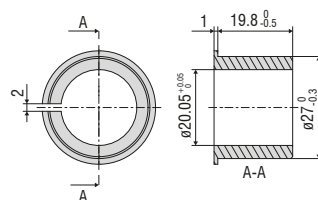

Sensors and Systems from Micro-Epsilon



Sensors and systems for displacement, distance and position



Sensors and measurement devices for non-contact temperature measurement



Measuring and inspection systems for metal strips, plastics and rubber

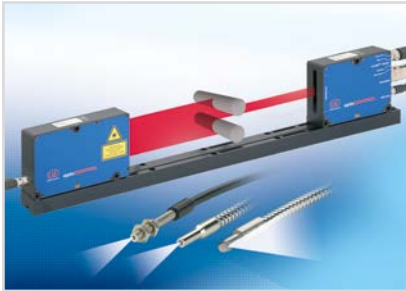

Optical micrometers and fiber optics, measuring and test amplifiers



Color recognition sensors, LED analyzers and inline color spectrometers



3D measurement technology for dimensional testing and surface inspection