









# More Precision

**interferoMETER** // Ultra-precise white light interferometers



# Absolute distance measurement with subnanometer resolution

## interferoMETER 5600-DS

-  Distance measurement with subnanometer precision
-  Best-in-Class: Resolution < 30 picometers
-  Absolute measurement, suitable for step profiles
-  Compact and robust sensors with large offset distance
-  Measuring rate up to 6 kHz for high speed measurements
-  **INTERFACE** Ethernet / EtherCAT / RS422 / PROFINET / EtherNet/IP



### Designed for high-resolution distance measurements in clean rooms & vacuums

The white light interferometer IMS5600-DS is used for distance measurements with the highest precision. The controller offers a special calibration with intelligent evaluation and enables absolute measurements with subnanometer resolution. The interferometer is used for measurement tasks with the highest accuracy requirements, e.g., in electronics and semiconductor production. For vacuum applications, Micro-Epsilon offers special sensors, cables and feed-through accessories. These sensors and cables are particle-free to a high degree and can even be used in UHV.

### Absolute distance measurement with large measuring range and offset distance

The IMS5600-DS is used for high-precision displacement and distance measurements. The system provides absolute measurement values and can therefore also be used for distance measurement of step profiles. Thanks to the absolute measurement, sampling is performed without signal loss. When measuring on moving objects, the differences in height of heels, steps and depressions can thus be reliably detected. The measuring system offers sub-nanometer resolution with a large offset distance in relation to the measuring range.

### Multi-peak distance measurement

With multi-peak distance measurement on transparent objects, up to 14 distance values can be evaluated. For example, the distance between the glass and the mask can be determined. If required, the controller can calculate the glass thickness based on the peaks.

 **14 distance values in a measuring range of 2.1 mm**

#### Multi-peak distance measurement

With multi-peak distance measurement, up to 14 distance values can be evaluated. This allows the distance between the glass and the mask to be determined.

ø 10 mm

Due to their extremely compact size, these sensors can also be integrated into restricted spaces.

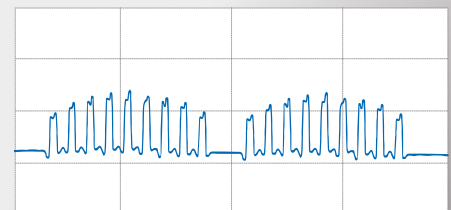

#### Absolute measurement of step profiles

Due to the absolute thickness measurement, step profiles are detected with high signal stability and subnanometer resolution.

Model		IMS5600-DS19	IMS5600MP-DS19
Measuring range	Distance	2.1 mm	
	Thickness	-	0.010 ... 1.3 mm
Start of measuring range		approx. 19 mm	
Resolution <sup>1)</sup>		< 30 pm	
Measuring rate		continuously adjustable from 100 Hz to 6 kHz	
Linearity <sup>2)</sup>		< ±10 nm	< ±10 nm for the first distance < ±100 nm for each further distance
Temperature stability	Sensor	Linearity: typ. 0.1 nm / K (without offset displacement)	
	Controller	temperature compensated, stability < 10 ppm between +15 ... +35 °C	
Multi-layer measurement		-	up to 13 layers
Light source		NIR-SLED, wavelength 840 nm Pilot laser: laser LED, wavelength 635 nm	
Laser class		Class 1 according to DIN EN 60825-1: 2015-070 Pilot laser: Class 1, power (< 0.2 mW)	
Light spot diameter <sup>3)</sup>		10 µm	
Measuring angle <sup>4)</sup>		±2°	
Target material		Glass, reflecting or diffuse surfaces <sup>5)</sup>	
Supply voltage		24 VDC ± 15 %	
Power consumption		approx. 10 W (24 V)	
Signal input		Sync in, trigger in, 2x encoders (A+, A-, B+, B-, index)	
Digital interface		Ethernet / EtherCAT / RS422 / PROFINET <sup>6)</sup> / EtherNet/IP <sup>6)</sup>	
Analog output		4 ... 20 mA / 0 ... 10 V (16 bit D/A converter)	
Switching output		Error1-Out, Error2-Out	
Digital output		sync out	
Connection	Optical	Pluggable optical fiber via E2000 socket (controller) and FC socket (vacuum feedthrough); pluggable UHV optical fiber via FC socket (vacuum feedthrough and sensor); standard lengths 3 m, 5 m and 10 m; other cable lengths on request; bending radius: static 30 mm, dynamic 40 mm	
	Electrical	3-pin supply terminal strip; encoder connection (15-pin, HD-sub socket, max. cable length 3 m, 30 m with external encoder supply); RS422 connection socket (9-pin, Sub-D, max. cable length 30 m); 3-pin output terminal strip (max. cable length 30 m); 11-pin I/O terminal strip (max. cable length 30 m); RJ45 socket for Ethernet (out) / EtherCAT (in/out) (max. cable length 100 m)	
Mounting	Sensor	Clamping, mounting adapter (see accessories)	
	Controller	free-standing, DIN rail mounting	
Temperature range	Storage	-20 ... +70°C	
	Operation	Sensor: +5 ... +70 °C; Controller: +15 ... +35 °C	
Shock (DIN EN 60068-2-27)		15 g / 6 ms in XY axis, 1000 shocks each	
Vibration (DIN EN 60068-2-6)		2 g / 20 ... 500 Hz in XY axis, 10 cycles each	
Protection class (DIN EN 60529)	Sensor	IP65 IP40 (option / VAC)	
	Controller	IP40	
Vacuum		Optional UHV (cable and sensor)	
Material	Sensor	Stainless steel	
	Controller	Aluminum housing, passive cooling	
Control and indicator elements		Multifunction button: two adjustable functions and reset to factory settings after 10 s; web interface for setup: selectable presets, freely selectable averaging, data reduction, setup management; 6 x color LEDs for intensity, range, SLED, pilot laser, status and power; pilot laser: can be switched on for sensor alignment	

All data at constant ambient temperature (24 ± 2 °C)

<sup>1)</sup> Measuring rate 0.5 kHz, moving average over 64 values, measured differentially between the front and back of a thin glass plate in the mid of the measuring range (2 sigma)

<sup>2)</sup> Maximum deviation from reference system over entire measuring range, measured on front surface of ND filter

<sup>3)</sup> In the mid of the measuring range

<sup>4)</sup> Maximum sensor tilt angle that produces a usable signal on polished glass (n = 1.5) in the mid of the measuring range.

The accuracy decreases when approaching the limit values.

<sup>5)</sup> Non-transparent materials require optically dense surface at a wavelength of 840 nm

<sup>6)</sup> Optional connection via interface module (see accessories)

# Dimensions interferoMETER

## IMS5400-DS sensor

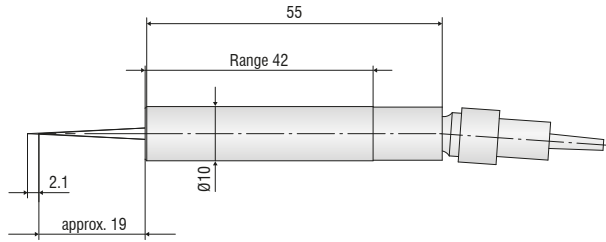

## IMS5400-TH45 sensor

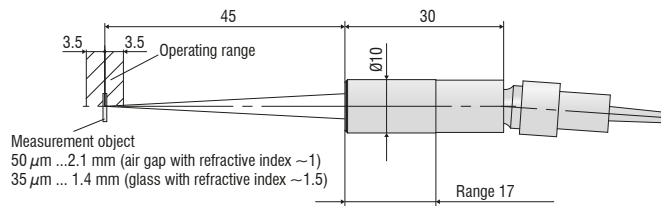

## IMS5400-TH70 sensor

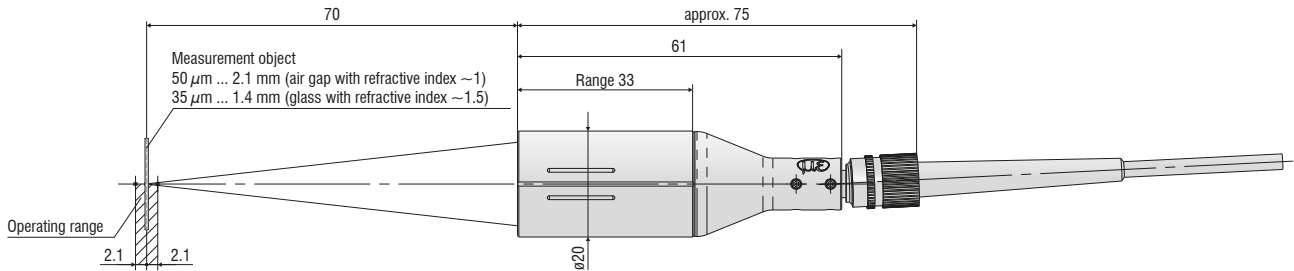

## IMS5400-DS / IMS5400-TH / IMS5600-DS controllers

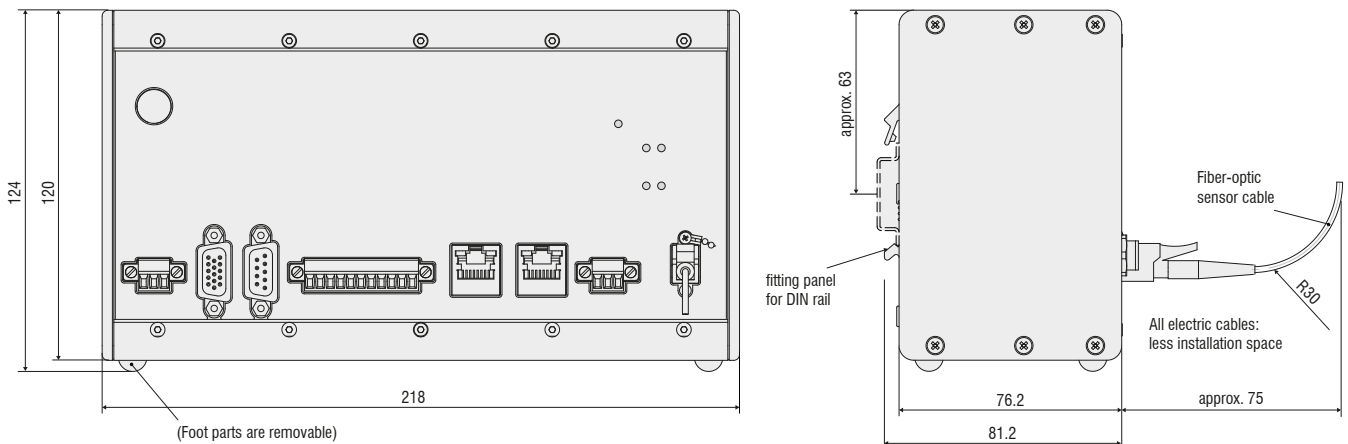

# Accessories

## interferoMETER

### Cables

Standard E2000/APC (controller) and FC/APC connector (sensor)

C5401-2	Optical fiber, length 2 m
C5401-3	Optical fiber, length 3 m
C5401-5	Optical fiber, length 5 m
C5401-10	Optical fiber, length 10 m
Other lengths up to 20 m on request	

Drag chain E2000/APC (controller) and FC/APC connector (sensor)

C5401-3(010)	Optical fiber, length 3 m
C5401-5(010)	Optical fiber, length 5 m
C5401-10(010)	Optical fiber, length 10 m
Other lengths up to 20 m on request	

Vacuum cable FC/APC connector

C5400-1/VAC	Optical fiber, length 1 m
C5400-2/VAC	Optical fiber, length 2 m
C5400-5/VAC	Optical fiber, length 5 m

### Flange for vacuum feed through

C5405/VAC/1/CF16	CF flange
C5405/VAC/1/KF16	KF flange

### Mounting Adapter

MA5400- 10	Mounting adapter for IMP-DS19/ -TH45
MA5400- 20	Mounting adapter for IMP-TH70

### Other accessories

SC2471-x/IF2008	IMC5400/5600 connector cable+ IF2008/PCIE, length 3 m / 10 m
SC2471-x/RS422/OE	IMC5400/5600 interface cable + IF2001/USB, length 3 m / 10 m
IF2001/USB	RS422/USB converter
IF2008/PCIE	Interface card
IF2030/PNET	Interface module for PROFINET integration
PS2020	Power supply 24V / 2.5A
EC2471-3/OE	Encoder cable, 3 m

### E2000/APC standard connector

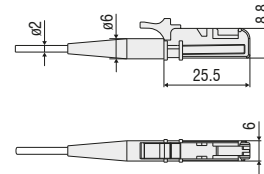

### FC/APC standard connector

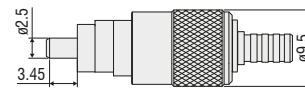

C5405/VAC/1/CF16  
C5405/VAC/1/KF16

# Accessories interferoMETER

## Sensor mounting adapter

For DS19/TH45:  
MA5400-10

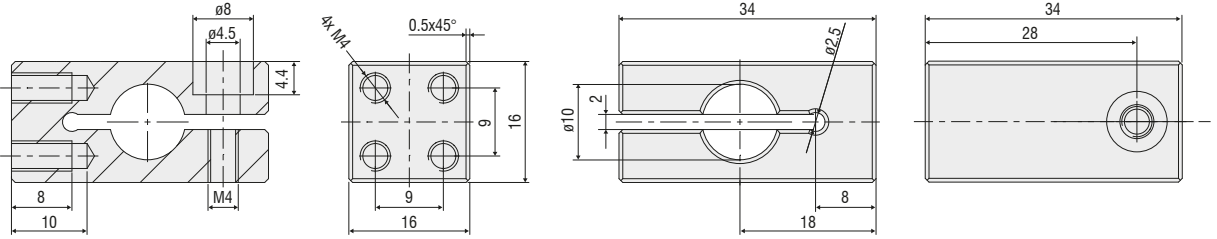

For TH70:  
MA5400-20

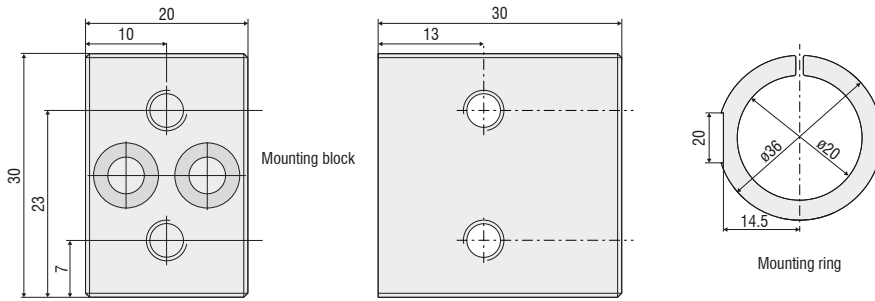

(dimensions in mm, not to scale)

## Adjustable mounting adapter

The adjustable JMA mounting adapter simplifies the alignment and fine adjustment of interferometric sensors. You can integrate the sensors with the adapter directly into the machine and then align them directly on site. This corrects, e.g. minor deviations caused by mounting and compensates for tilted measuring objects. With two-sided thickness measurements, the mounting adapter supports the fine alignment of the two measuring points.

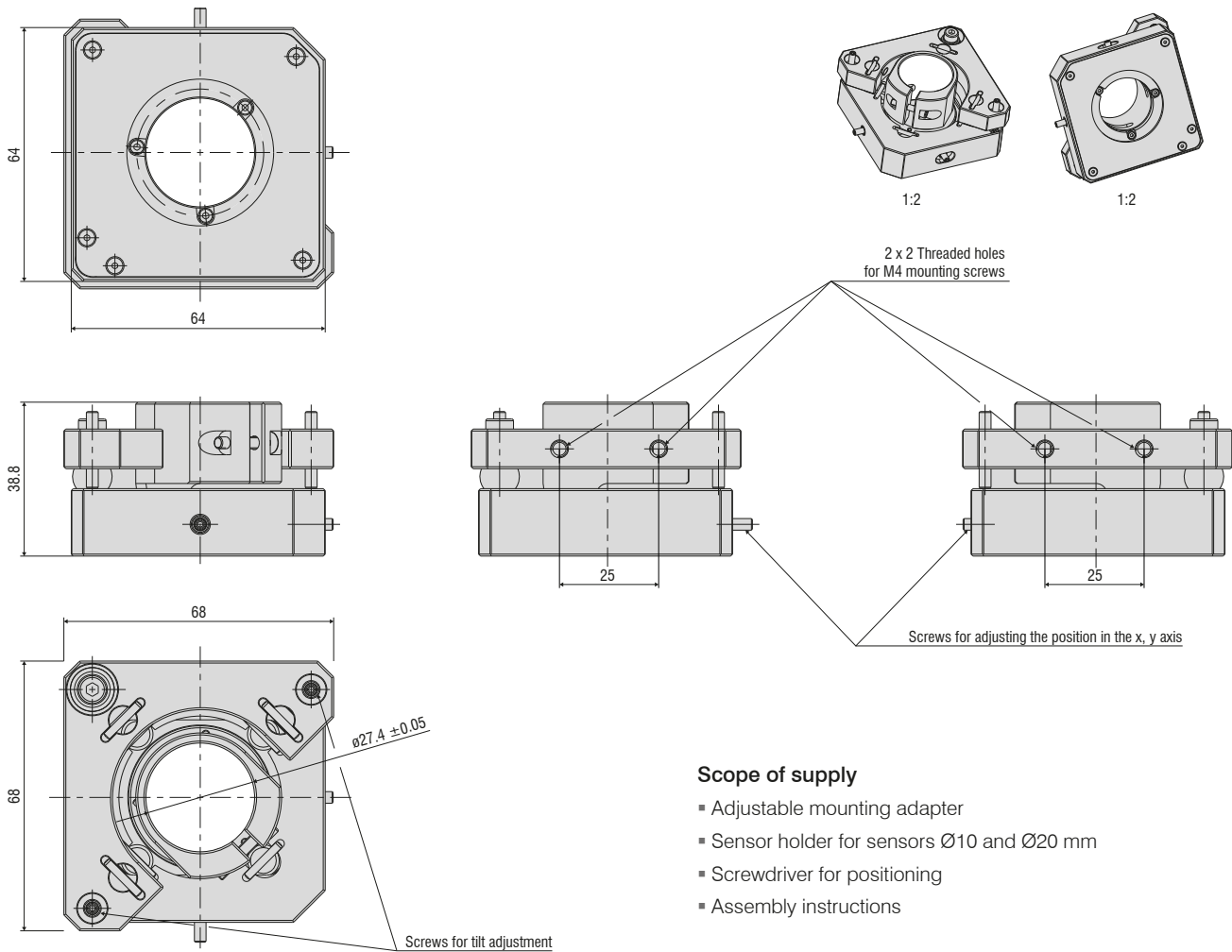

## Sensor holder

Sensor holder for JMA-10

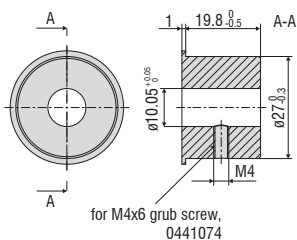

Sensor holder for JMA-20

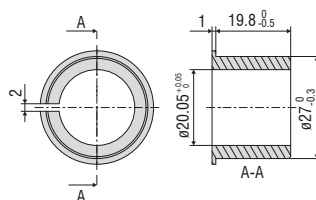



## Sensors and Systems from Micro-Epsilon



Sensors and systems for displacement, distance and position



Sensors and measurement devices for non-contact temperature measurement



Measuring and inspection systems for metal strips, plastics and rubber



Optical micrometers and fiber optics, measuring and test amplifiers



Color recognition sensors, LED analyzers and inline color spectrometers



3D measurement technology for dimensional testing and surface inspection