



# More Precision

**thermoMETER** // Non-contact infrared temperature sensors





### thermoMETER CT

Non-contact IR temperature sensor for common applications

- Measuring range from -50 °C to 975 °C
- One of the smallest 22:1 infrared sensors worldwide
- Up to 180 °C ambient temperature without cooling
- Separate controller with programming keys and backlit display
- Selectable and scalable analog output, optional digital interfaces
- Exchangeable sensors
- Best price sensor

#### Optical specifications thermoMETER CT

□ = smallest spot size / focal point (mm)

##### Standard Focus

SF02	2:1	5	53.8	102.5	151.3	200	251.3	302.5	353.8	405						
	distance in mm	0	100	200	300	400	500	600	700	800						
SF15	15:1	6.5	10.3	14.1	17.9	21.7	25.4	30.9	37.1	43.3	49.5	55.8	62	68.2	74.4	80.7
	distance in mm	0	75	150	225	300	375	450	525	600	675	750	825	900	975	1050
SF22	22:1	6.5	10.9	15.2	19.5	23.9	28.3	32.6	37	41.3	45.7	50				
	distance in mm	0	110	220	330	440	550	660	770	880	990	1100				

##### Close Focus (with optionally available CF lens)

CF02	2:1	5	3.9	2.8	2.5	4.8	6.4	8	11.3	14.6						
	distance in mm	0	10	20	23	30	35	40	50	60						
CF15	15:1	6.5	3.7	0.8	4.4	8.1	11.8	15.4	19.1	22.7						
CF22	22:1	7	3.8	0.6	4.4	8.2	12	15.8	19.6	23.4						
	distance in mm	0	5	10	15	20	25	30	35	40						

Model	CT-SF02-C3	CT-SF15-C3	CT-SF22-C3
Optical resolution	2:1	15:1	22:1
Temperature range <sup>1)</sup>	-50 °C to 600 °C	-50 °C to 600 °C	-50 °C to 975 °C
Spectral range	8 to 14 μm		
System accuracy <sup>2)</sup>	±1 % or ±1 °C		
Repeatability <sup>2)</sup>	±0.5 % or ±0.5 °C		
Temperature resolution	0.1 °C		
Response time	150 ms (95 %)		
Emissivity/gain <sup>1)</sup>	0.100 to 1.100		
Transmissivity/gain <sup>1)</sup>	0.100 to 1.100		
Signal processing <sup>1)</sup>	peak hold, valley hold, average; extended hold function with threshold and hysteresis		
Certificate of calibration	optional		
Outputs/analog	channel 1	0/4 to 20 mA, 0 to 5/10 V, thermocouple J, K	
	channel 2	sensor temperature (-20 to 180 °C as 0 to 5 V or 0 to 10 V), alarm output	
Outputs/analog	optional	relays: 2 x 60 VDC/42 VAC; 0.4 A; electrically isolated	
Outputs/digital	optional	USB, RS232, RS485, Modbus RTU, Profibus DP, Ethernet	
Output impedances	current output	mA max. 500 Ω (with 8 to 36 VDC)	
	voltage output	min. 100 kΩ load impedance, thermocouple 20 Ω	
Inputs	programmable functional inputs for external emissivity adjustment ambient temperature compensation, trigger (reset of hold functions)		
Cable length	1 m, 3 m (standard), 8 m, 15 m		
Power supply	8 to 36 VDC; max. 100 mA		
Protection class	IP65 (NEMA-4)		
Ambient temperature	sensor	-20 °C to 130 °C	-20 °C to 180 °C
	controller	0 °C to 85 °C	
Storage temperature	sensor	-40 °C to 130 °C	-40 °C to 180 °C
	controller	-40 °C to 85 °C	
Relative humidity	10 to 95 %, non-condensing		
Vibration	sensor	IEC 68-2-6: 3 G, 11 to 200 Hz, any axis	
Shock	sensor	IEC 68-2-27: 50 G, 11 ms, any axis	
Weight	sensor: 40 g; controller: 420 g		

<sup>1)</sup> adjustable via programming keys or software

<sup>2)</sup> ambient temperature 23 ±5 °C; whichever is greater

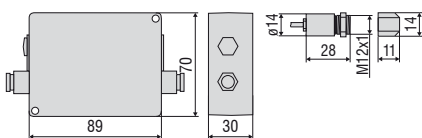

### Product identification

CT-	SF02-	C3
Cable length [1 m / 3 m (standard) / 8 m / 15 m]		
Focus [SF02 / SF15 / SF22]		
thermoMETER CT		

### Accessories page 40 - 43

- Ancillary CF lens
- Protective window
- Mounting bracket / mounting bolt
- Air purge collar
- Right angle mirror
- Rail mount adapter for controller
- Massive housing
- Protective tube
- Laser sighting aid
- Digital-interface kits
- Accessories kit for use in Ex areas
- Certificate of calibration

**CT / CTfast / CTM1/M2/M3**

**controller**

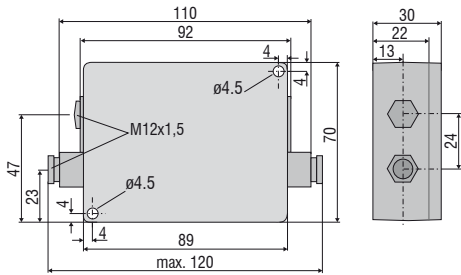

**ancillary CF lens (optional)**



**sensor**

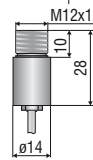

**CThot / CTP-3 / CTP-7**

**controller**

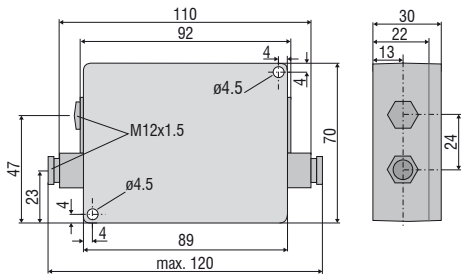

**sensor with protective housing**

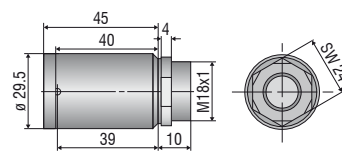

**CTM3-XL**

**controller**

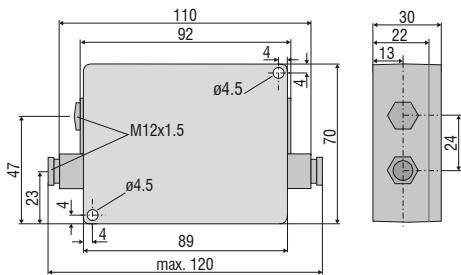

**sensor**

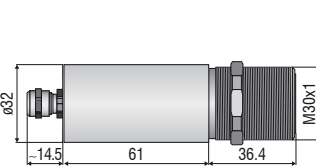

**CTex**

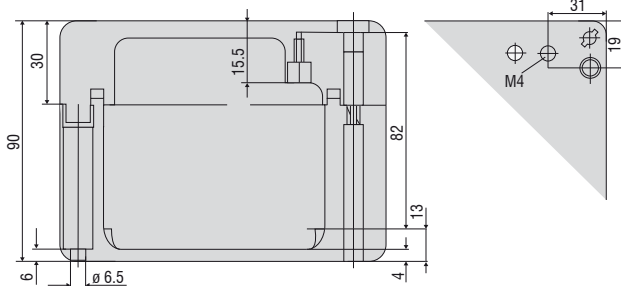
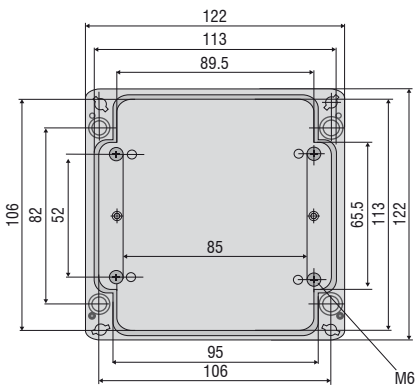

Mechanical accessories		
Art. No.	Model	
2970203	TM-FB-CT	Mounting bracket, fixed
2970325	TM-FB2-CT	Mounting bracket, adjustable in one axis, for simultaneous assembly of CT sensor and laser sighting aid
2970336	TM-FBMH-CT	Mounting bracket, adjustable in one axis, for massive housing
2970204	TM-AB-CT	Mounting bracket, adjustable in 2 axes
2970205	TM-MB-CT	Mounting bolts with M12x1 thread
2970206	TM-MG-CT	Mounting fork, adjustable in 2 axes, with M12x1 fastening
2970207	TM-AP-CT	Air purge collar for sensors from 10:1 lens
2970335	TM-APS-CT	Air purge collar for sensors from 10:1 lens made from stainless steel
2970208	TM-AP2-CT	Air purge collar for sensor with 2:1 lens
2970209	TM-APL-CT	Air purge collar, laminar
2970210	TM-APLCF-CT	Air purge collar, laminar with integrated ancillary CF lens
2970357	TM-APLCFH-CT	Air purge collar, laminar with integrated ancillary CF lens for M1/M2/M3/M5 sensors
2970386	TM-APMH-CT	Air purge collar made from stainless steel for massive housing
2970463	TM-TAS-CT	Pivoted joint for CT sensors
2970211	TM-RAM-CT	Right angle mirror for measurements 90 °C to the sensor axis
2970212	TM-RAIL-CT	Rail mount adapter for CT controller
2970213	TM-COV-CT	Closed cover for controller
2970214	TM-MHS-CT	Massive housing made from stainless steel
2970215	TM-MHSFC-CT	Massive housing made from stainless steel with integrated ancillary CF lens
2970358	TM-MHSFCFH-CT	Massive housing made from stainless steel with integrated ancillary CF lens for M1/M2/M3/M5 sensors
2970216	TM-MHA-CT	Massive housing made from anodized aluminum
2970217	TM-MHACF-CT	Massive housing made from stainless steel with integrated ancillary CF lens
2970359	TM-MHACFH-CT	Massive housing made from anodized aluminum with integrated ancillary CF lens for M1/M2/M3/M5 sensors
2970326	TM-PA-CT	Pipe adapter for the mounting of reflection protection tubes
2970327	TM-ST20-CT	Reflection protection tube, length 20 mm
2970328	TM-ST40-CT	Reflection protection tube, length 40 mm
2970329	TM-ST88-CT	Reflection protection tube, length 88 mm
2970221	TM-LST-CT	Laser sighting aid for CT sensors incl. batteries (2xAlkaline AA)
2970300	TM-LSTOEM-CT	OEM laser sighting aid, 635 nm, 3.5 m cable, for connection to CT controller
2970300.008	TM-LSTOEM-CT(008)	OEM laser sighting aid, 635 nm, 8 m cable, for connection to CT controller

Optical accessories		
Art. No.	Model	
2970201	TM-CF-CT	Ancillary CF lens (only for SF models)
2970202	TM-PW-CT	Protective window (only for SF models)
2970297	TM-CFAG-CT	Ancillary lens with external thread
2970330	TM-CFH-CT	Ancillary lens for M1/M2/M3/M5 sensors
2970331	TM-CFHAG-CT	Ancillary lens with external thread for M1/M2/M3/M5 sensors
2970299	TM-PWAG-CT	Protective window with external thread
2970332	TM-PWH-CT	Protective window for M1/M2/M3/M5 sensors
2970333	TM-PWHAG-CT	Protective window with external thread for M1/M2/M3/M5 sensors

Interfaces		
Art. No.	Model	
2970729	TM-USBK-CT	USB-Interface-board, cable with Micro-USB plug and adapter for USB-C and USB-A, CompactConnect software (as download), Quick reference, second cable gland for controller
2970224	TM-RS232K-CT	RS232 interface: RS232 interface, computer cable, CompactConnect software, second cable gland for controller
2970338	TM-RS485USBK-CTL	RS485-USB-adapter, incl. PC cable, CompactConnect software and CTmulti, second cable gland for use with interface board TM-RS485B-CT
2970226	TM-RS485B-CT	RS485 interface board incl. second cable gland
2970227	TM-CANK-CT	CAN-Bus interface for thermoMETER CT/ protocol: CANopen presets: module address 20 (14H), 250 kBaud, 0-60 °C
2970228	TM-PFBDPK-CT	Profibus-DPv1 interface for thermoMETER CT with plug-in connection
2970229	TM-ETHNK-CT	Ethernet-Kit: interface board, external Ethernet adapter, CompactConnect software, second cable gland
2970230	TM-RI-CT	Relay interface: two electrically isolated relays, 60 VDC/ 42 VAC <sub>eff</sub> , 0.4 A

Calibration		
Art. No.	Model	
2970231	TM-CERT-CT	Certificate of calibration
2970310	TM-HTCERT-CT	Certificate of calibration for CTM sensors

CTM3-XL		
Art. No.	Model	
2970352	TM-FBXL-CT	Mounting bracket, adjustable in one axis
2970353	TM-ABXL-CT	Mounting bracket, adjustable in 2 axes
2970354	TM-APXL-CT	Air purge collar, stainless steel
2970361	TM-XLCERT-CT	Certificate of calibration



TM-FB-CT Mounting bracket, adjustable in one axis

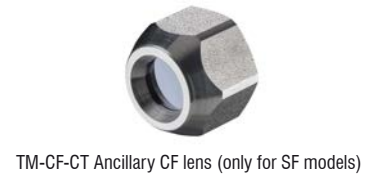

TM-CF-CT Ancillary CF lens (only for SF models)

TM-CFAG-CT Ancillary CF lens with external thread  
TM-PWAG-CT Protective window with external thread

TM-AB-CT Mounting bracket, adjustable in two axes

TM-MB-CT mounting bolt with M12x1 thread  
adjustable in one axisTM-APL-CT Air purge collar, laminar and  
TM-MG-CT Mounting fork

TM-MG-CT Mounting fork with M12x1 thread, adjustable in two axes

TM-APLCF-CT  
Ancillary CF lens/protective window - integrable variant  
for laminar air purge collar

TM-RAIL-CT rail mount adapter for controller

TM-KF40GE-CT KF40 Flange with Ge window  
TM-KF40B270-CT KF40 Flange for CTM-1,-2,-3  
with B270 windowTM-APMH-CT  
Air purge collar made from stainless steel  
for massive housing

TM-PA-CT Pipe adapter for reflection protection tube



TM-ST40-CT Reflection protection tube





TM-LST-CT Laser sighting aid, battery-operated  
(2x Alkaline AA), for alignment of CT sensors  
(dimensions identical to CT sensor)



TM-FB2-CT  
Mounting bracket for sensor and laser sighting aid



TM-RAM-CT  
Right angle mirror



TM-MHS-CT Massive housing, stainless steel  
TM-MHA-CT Massive housing, aluminum

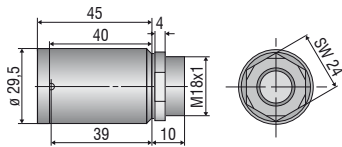

TM-TAS-CT Pivoted joint for CT sensors



Dirt and deposit on the lens like smoke, steam and high air humidity (condensation) are avoided or reduced by using an air purge collar.

TM-AP-CT  
Standard air purge collar for 10:1 / 15:1 / 22:1 lenses  
TM-APS-CT  
Air purge collar, stainless steel



TM-AP2-CT  
Standard air purge collar for 2:1 lens

## Infrared thermal imagers from Micro-Epsilon



### thermoIMAGER TIM Compact thermal imaging cameras for industrial temperature monitoring

- Temperature range from -20 °C to 2450 °C
- Ideal for OEM
- Real-time thermography using license-free software
- Protective housing for harsh environments
- Special variants for the glass, metal and plastics industries