



Operating Instructions  
**optoNCDT 1900**  
**EtherCAT**

ILD1900-2-IE  
ILD1900-10-IE  
ILD1900-25-IE  
ILD1900-50-IE  
ILD1900-100-IE

ILD1900-200-IE  
ILD1900-500-IE

ILD1900-2LL-IE  
ILD1900-6LL-IE  
ILD1900-10LL-IE  
ILD1900-25LL-IE  
ILD1900-50LL-IE

Intelligent laser-optical displacement measurement

MICRO-EPSILON  
MESSTECHNIK  
GmbH & Co. KG  
Königbacher Str. 15

94496 Ortenburg / Deutschland

Tel. +49 (0) 8542 / 168-0  
Fax +49 (0) 8542 / 168-90  
e-mail [info@micro-epsilon.com](mailto:info@micro-epsilon.com)  
[www.micro-epsilon.com](http://www.micro-epsilon.com)

optoNCDT 1900

**EtherCAT®** 

EtherCAT® is registered trademark and patented technology,  
licensed by Beckhoff Automation GmbH, Germany.

# Contents

- 1. Safety ..... 9**
  - 1.1 Symbols Used .....9
  - 1.2 Warnings .....9
  - 1.3 Notes on CE Marking .....10
  - 1.4 Intended Use .....10
  - 1.5 Proper Environment.....11
  
- 2. Laser Safety ..... 12**
  - 2.1 General .....12
  - 2.2 Laser Class 2 .....12
  - 2.3 Laser Class 3R.....14
  
- 3. Functional Principle, Technical Data ..... 16**
  - 3.1 Short Description .....16
  - 3.2 Advanced Surface Compensation .....17
  - 3.3 Technical Data .....18
    - 3.3.1 ILD1900-xx.....18
    - 3.3.2 ILD1900-xxLL.....20
  
- 4. Delivery ..... 22**
  - 4.1 Unpacking, Included in Delivery.....22
  - 4.2 Storage .....22
  
- 5. Assembly ..... 23**
  - 5.1 Notes for Operation .....23
    - 5.1.1 Reflectance of Target Surface .....23
    - 5.1.2 Interferences.....24
      - 5.1.2.1 Ambient Light.....24
      - 5.1.2.2 Color Differences .....24
      - 5.1.2.3 Thermal Influences .....24
      - 5.1.2.4 Mechanical Vibrations .....24
      - 5.1.2.5 Motion Blur .....24
      - 5.1.2.6 Surface Roughness .....25
      - 5.1.2.7 Angular Influences .....26
    - 5.1.3 Optimizing the Measurement Accuracy.....27

5.2	Mechanical Fastening, Dimensional Drawing .....	28
5.2.1	General .....	28
5.2.2	Mounting.....	28
5.3	Control and Indicator Elements .....	30
5.4	Electrical Connections.....	31
5.4.1	RJ45, PoE Connections .....	31
5.4.2	RJ45 Connection .....	32
5.4.3	Pin Assignment.....	33
5.4.4	Supply Voltage .....	34
5.4.5	Turning on the Laser.....	35
5.4.6	Plug-In Connection, Supply and Output Cable .....	36
<b>6.</b>	<b>Operation .....</b>	<b>37</b>
6.1	Getting Ready for Operation .....	37
6.2	Operation via Web Interface, Ethernet .....	38
6.2.1	General .....	38
6.2.2	Access via Web Interface .....	39
6.2.3	Measurement Task Selection .....	41
6.2.4	Display of Measurement Values in the Web Browser .....	42
6.2.5	Video Signal Display in the Web Browser.....	44
6.3	Parameter Setting via EtherCAT .....	46
6.4	Timing, Measurement Value Cycles .....	46
6.5	Operation via Membrane Key.....	47
<b>7.</b>	<b>Setting Sensor Parameters .....</b>	<b>48</b>
7.1	Preliminary Remarks about the Setting Options.....	48
7.2	Parameters Overview .....	48
7.3	Inputs .....	49
7.4	Data Recording.....	50
7.4.1	Preliminary Remarks .....	50
7.4.2	Measurement Configuration.....	50
7.4.3	Measuring Rate .....	50
7.4.4	ROI Masking .....	51
7.4.5	Exposure Mode .....	52
7.4.6	Peak Selection.....	53

7.5	Signal Processing .....	54
7.5.1	Preliminary Remarks .....	54
7.5.2	Averaging .....	54
	7.5.2.1    General .....	54
	7.5.2.2    Moving Average .....	55
	7.5.2.3    Recursive Average .....	56
	7.5.2.4    Median .....	56
7.5.3	Zeroing, Mastering .....	57
7.6	EtherCAT Digital Output .....	58
7.6.1	Values, Ranges .....	58
7.6.2	Behavior of the Digital Output .....	60
7.7	System Settings .....	62
7.7.1	General .....	62
7.7.2	Unit, Language .....	62
7.7.3	Load & Save .....	63
7.7.4	Import, Export .....	65
7.7.5	Reset Sensor .....	66
7.7.6	Bootmode .....	66
<b>8.</b>	<b>EtherCAT .....</b>	<b>67</b>
8.1	Preliminary Remarks .....	67
8.2	Saving the Settings, Continuing EtherCAT Operation .....	67
<b>9.</b>	<b>Cleaning .....</b>	<b>68</b>
<b>10.</b>	<b>Disclaimer .....</b>	<b>68</b>
<b>11.</b>	<b>Service, Repair .....</b>	<b>69</b>
<b>12.</b>	<b>Decommissioning, Disposal .....</b>	<b>69</b>

## Appendix

A 1	Optional Accessories.....	70
A 2	Factory Settings.....	71
A 3	Switching between EtherCAT and Ethernet Setup Mode.....	72
A 4	Switch between Ethernet Setup Mode and EtherCAT.....	73
A 5	EtherCAT Documentation.....	74
A 5.1	General.....	74
A 5.2	Introduction.....	75
A 5.2.1	Structure of EtherCAT® Frames.....	75
A 5.2.2	EtherCAT® Services.....	75
A 5.2.3	Addressing and FMMUs.....	76
A 5.2.4	Sync Manager.....	76
A 5.2.5	EtherCAT State Machine.....	77
A 5.2.6	CANopen over EtherCAT.....	77
A 5.2.7	Process Data PDO Mapping.....	78
A 5.2.8	Service Data SDO Service.....	78
A 5.3	CoE – Object Directory.....	79
A 5.3.1	Communication-Specific Standard Objects.....	79
A 5.3.1.1	Overview.....	79
A 5.3.1.2	Object 1000h: Device Type.....	80
A 5.3.1.3	Object 1008h: Manufacturer Device Name.....	80
A 5.3.1.4	Object 1009h: Hardware Version.....	80
A 5.3.1.5	Object 100Ah: Software Version.....	80
A 5.3.1.6	Object 1018h: Device Identification.....	80
A 5.3.1.7	TxPDO Mapping.....	81
A 5.3.1.8	Object 1C00h: Synchronous Manager Type.....	86
A 5.3.1.9	Object 1C12h: RxPDO Assign.....	86
A 5.3.1.10	Object 1C13h: TxPDO Assign.....	86
A 5.3.1.11	Object 1C32h: Synchronization Manager Input Parameters.....	87
A 5.3.1.12	Object 1C33h: Synchronization Manager Input Parameters.....	87
A 5.3.2	Manufacturer Specific Objects.....	89
A 5.3.2.1	Object 3000h: Light Source.....	90
A 5.3.2.2	Object 3200: Measurement Configuration, Measuring Rate, Evaluation Range, Exposure, Peak Selection, Error Handling.....	91
A 5.3.2.3	Object 3400: Averaging.....	92
A 5.3.2.4	Object 3450: Zeroing, Mastering.....	93
A 5.3.2.5	Object 3800: System Settings, Key Lock, Login, Password, Factory Settings.....	94
A 5.3.2.6	Object 3850: Measurement Task.....	95
A 5.3.2.7	Object 3851: Signal Quality.....	95

	A 5.3.2.8	Object 3852: Load, Save .....	96
	A 5.3.2.9	Object 3900: Sensor Information .....	96
A 5.4		Mappable Objects - Process Data.....	97
	A 5.4.1	General .....	97
	A 5.4.2	Object 6000: Exposure time .....	97
	A 5.4.3	Object 6001: Measuring Rate.....	98
	A 5.4.4	Object 6002: Timestamp .....	98
	A 5.4.5	Object 6003: Measurement counter .....	98
	A 5.4.6	Object 6004: Frame status .....	99
	A 5.4.7	Object 6005: Distance value, not linearized .....	99
	A 5.4.8	Object 6006: Intensity.....	99
	A 5.4.9	Object 6007: Distance value, linearized.....	100
	A 5.4.10	Object 6008: Peak distance .....	100
A 5.5		Error Codes for SDO Services.....	101
A 5.6		Oversampling.....	103
A 5.7		Update .....	105
	A 5.7.1	Update via FoE.....	105
	A 5.7.2	Update via EoE.....	105
A 5.8		Operational Modes .....	106
	A 5.8.1	Free Run .....	106
	A 5.8.2	Distributed Clocks SYNC0 Synchronization .....	106
	A 5.8.3	SM2/SM3 Synchronization .....	106
A 5.9		Meaning of RUN and ERR LEDs in EtherCAT Operation.....	107
A 5.10		EtherCAT Configuration with the Beckhoff TwinCAT® Manager .....	108





## 1. Safety

System operation assumes knowledge of the operating instructions.

### 1.1 Symbols Used

The following symbols are used in these operating instructions:



Indicates a hazardous situation which, if not avoided, may result in minor or moderate injury.



Indicates a situation that may result in property damage if not avoided.



Indicates a user action.



Indicates a tip for users.

Measurement

Indicates hardware or a software button/menu.

### 1.2 Warnings



Connect the power supply according to the regulations for electrical equipment.

- > Risk of injury
- > Damage to or destruction of the sensor



Avoid shocks and impacts to the sensor.

Damage to or destruction of the sensor

Install the sensor on a flat surface using only the mounting holes/threaded holes provided, any type of clamping is not permitted.

- > Damage to or destruction of the sensor

The supply voltage must not exceed the specified limits.

- > Damage to or destruction of the sensor

Protect the sensor cable against damage. Attach the cable without load, secure the cable after approx. 25 cm and the pigtail on the connector, e.g. using cable ties.

- > Destruction of the sensor, failure of the measuring device

**NOTICE**

Avoid constant exposure of the sensor to splashes of water.

> Damage to or destruction of the sensor

Avoid exposure of sensor to aggressive media (detergents, cooling emulsions).

> Damage to or destruction of the sensor

### 1.3 Notes on CE Marking

The following apply to the optoNCDT 1900 measuring system:

- EU Directive 2014/30/EU
- EU Directive 2011/65/EU

Products which carry the CE mark satisfy the requirements of the EU directives cited and the relevant applicable harmonized European standards (EN). The measuring system is designed for use in industrial environments.

The EU Declaration of Conformity and the technical documentation are available to the responsible authorities according to the EU Directives.

### 1.4 Intended Use

- The optoNCDT 1900 is designed for use in industrial and laboratory applications. It is used for
  - Measuring displacement, distance, position and thickness
  - Monitoring quality and checking dimensions
- The sensor must only be operated within the values specified in the technical data see Chap. 3.3.
- The sensor must be used in such a way that no persons are endangered or machines are damaged in the event of malfunction or total failure of the sensor.
- Take additional precautions for safety and damage prevention in case of safety-related applications.

## 1.5 Proper Environment

- Protection class: IP67 (applies only when sensor cable is plugged in)

Lenses are excluded from the protection class. Contamination of the lenses causes impairment or failure of the function.

- Temperature range:
  - Operation: 0 ... 50 °C
  - Storage: -20 ... 70 °C
- Humidity: 5 - 95% (non-condensing)
- Ambient pressure: Atmospheric pressure

**i** The protection class is limited to water, no penetrating liquids or the like.

## 2. Laser Safety

### 2.1 General

The optoNCDT 1900 operates with a semiconductor laser with a wavelength of 658 nm (visible/red) or 670 nm (visible/red).

When operating the optoNCDT 1900 sensors, the relevant regulations according to IEC 60825, Part 1 of 05/2014 and the applicable accident prevention regulations must be followed.

**i** If both warning labels are covered over when the unit is installed, the user must ensure that supplementary labels are applied.

Operation of the laser is indicated visually by the LED on the sensor, see Chap. 5.3.

The housing of the optical sensors may only be opened by the manufacturer, see Chap. 10.

For repair and service purposes, the sensors must always be sent to the manufacturer.

### 2.2 Laser Class 2

The sensors fall within laser class 2. The laser is operated on a pulsed mode, the maximum optical power is  $\leq 1$  mW. The pulse frequency depends on the adjusted measuring rate (0.25 ... 10 kHz). The pulse duration of the peaks is regulated depending on the measuring rate and reflectivity of the target and can be 4 up to 3995  $\mu$ s.



Laser radiation. Close your eyes or immediately turn away if the laser beam hits the eye. Irritation or injury of the eyes possible.

**i** Observe the laser protection regulations.

Although the laser output is low, directly looking into the laser beam must be avoided. Close your eyes or immediately turn away if the laser beam hits the eye. Lasers of Class 2 are not subject to notification and a laser protection officer is not required.

The following warning labels are attached to the sensor cable:



Fig. 1 Laser labels on the sensor cable

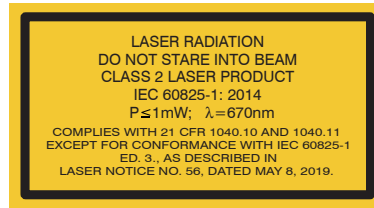

Fig. 2 Laser warning sign on the sensor housing

During operation of the sensor, the pertinent regulations according to IEC 60825-1 on „Safety of laser products“ must be fully observed at all times. The sensor complies with all applicable laws for the manufacturer of laser devices.

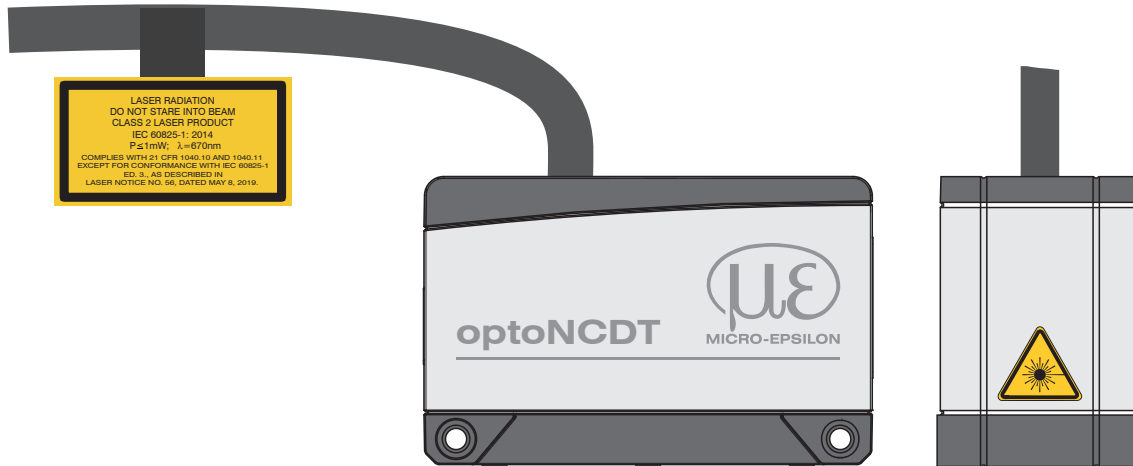

Fig. 3 Sensor cable and sensor with laser sign, class 2

## 2.3 Laser Class 3R

The sensors fall within laser class 3R. The laser is operated on a pulsed mode, the maximum optical power is  $\leq 5$  mW. The pulse frequency depends on the adjusted measuring rate (0.25 ... 10 kHz). The pulse duration of the peaks is regulated depending on the measuring rate and reflectivity of the target and can be 4 up to 3995  $\mu$ s.



Laser radiation. Use suitable protective equipment and close your eyes or immediately turn away if the laser beam hits the eye. Irritation or injury of the eyes possible.

- Observe the laser protection regulations.

Accordingly, the following applies: The accessible laser radiation is harmful to the eyes. Looking directly into the laser beam is harmful to the eyes with laser class 3R devices. Reflections of shiny or mirroring surfaces are also harmful to the eyes.

Class 3R laser sensors require a laser protection officer.

Mark the laser area recognizable and everlasting. During operation the laser area has to be restricted and marked.

The following warning labels are attached to the sensor cable:



Fig. 4 Laser labels on the sensor cable

Fig. 5 Laser warning sign on the sensor housing

During operation of the sensor, the pertinent regulations according to IEC 60825-1 on „Safety of laser products“ must be fully observed at all times. The sensor complies with all applicable laws for the manufacturer of laser devices.

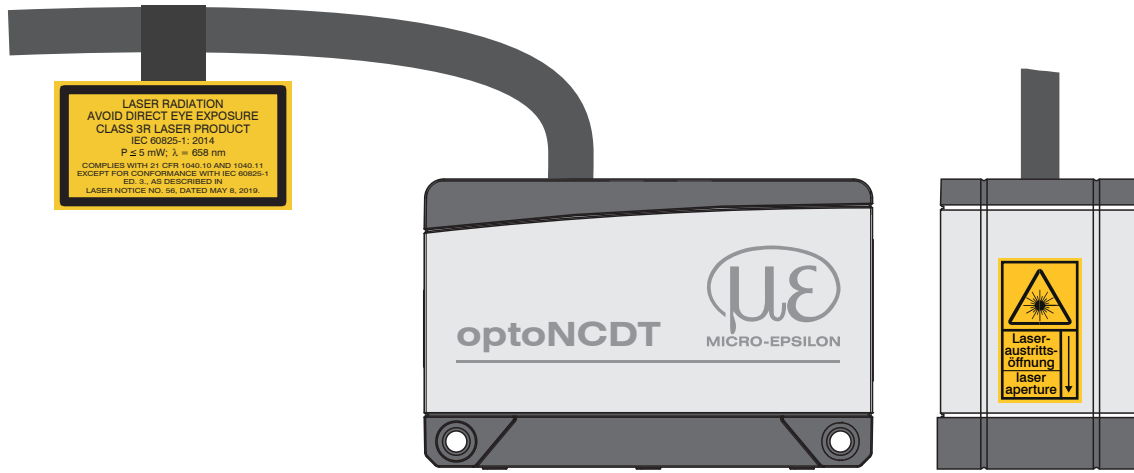

Fig. 6 Sensor cable and sensor with laser sign, class 3R

### 3. Functional Principle, Technical Data

#### 3.1 Short Description

The optoNCDT 1900 operates according to the principle of optical triangulation, i.e. a visible, modulated light spot is projected onto the surface of the measuring object.

The diffuse part of the reflection of this light spot is imaged on a spatial resolution element (CMOS) by a receiver optic arranged at a certain angle to the optical axis of the laser beam.

A signal processor in the sensor calculates the distance between the light spot on the target and the sensor from the output signal of the CMOS element. The distance value is linearized and output via the EtherCAT interface.

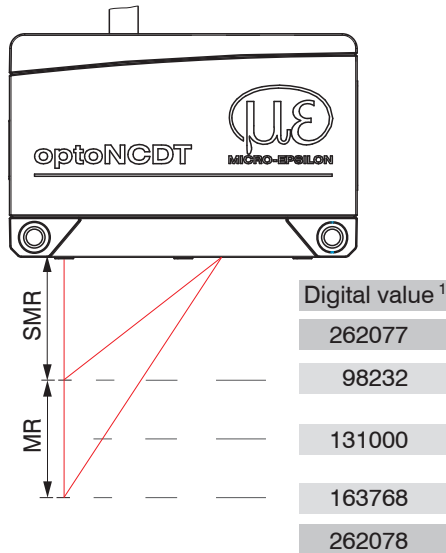

MR = Measuring range  
 SMR = Start of measuring range  
 MMR = Mid of measuring range  
 EMR = End of measuring range

Fig. 7 Term definitions

1) For displacement values without zero setting or mastering.



## **3.2      Advanced Surface Compensation**

The optoNCDT 1900 is equipped with an intelligent surface control feature. New algorithms generate stable measurement results even on demanding surfaces where changing reflections occur. Furthermore, these new algorithms compensate for ambient light up to 50,000 lux. Therefore, this is the sensor with the highest resistance to ambient light in its class which can even be used in strongly illuminated environments.

### 3.3 Technical Data

#### 3.3.1 ILD1900-xx

Model	ILD1900-	2-IE	6-IE	10-IE	25-IE	50-IE	100-IE	200-IE	500-IE
Measuring range	mm	2	6	10	25	50	100	200	500
Start measuring range	mm	15	17	20	25	40	50	60	100
Mid measuring range	mm	16	20	25	37.5	65	100	160	350
End measuring range	mm	17	23	30	50	90	150	260	600
Measuring rate <sup>1</sup>		continuously adjustable between 0.25 ... 10 kHz 7 adjustable stages: 10 kHz / 8 kHz / 4 kHz / 2 kHz / 1.0 kHz / 500 Hz / 250 Hz							
Linearity	$\mu\text{m}$	$\leq \pm 1$	$\leq \pm 1.8$	$\leq \pm 2$	$\leq \pm 5$	$\leq \pm 10$	$\leq \pm 30$	$\leq \pm 100$	$\leq \pm 400$
	% FSO	$\leq \pm 0.05$	$\leq \pm 0.03$	$\leq \pm 0.02$			$\leq \pm 0.03$	$\leq \pm 0.05$	$\leq \pm 0.08$
Repeatability <sup>2</sup>	$\mu\text{m}$	< 0.1	< 0.25	< 0.4	< 0.8	< 1.6	< 4	< 8	< 20 ... 40
Temperature stability <sup>3</sup>	FSO/K	$\pm 0.005\%$							
Light spot diameter ( $\pm 10\%$ ) <sup>4</sup>	SMR in $\mu\text{m}$	60 x 75	85 x 105	115 x 150	200 x 265	220 x 300	310 x 460	950 x 1200	950 x 1200
	MMR in $\mu\text{m}$	55 x 65	57 x 60	60 x 65	70 x 75	95 x 110	140 x 170		
	EMR in $\mu\text{m}$	65 x 75	105 x 120	120 x 140	220 x 260	260 x 300	380 x 410		
	smallest diameter	55 x 65 $\mu\text{m}$ with 16 mm	57 x 60 $\mu\text{m}$ with 20 mm	60 x 65 $\mu\text{m}$ with 25 mm	65 x 70 $\mu\text{m}$ with 35 mm	85 x 90 $\mu\text{m}$ with 55 mm	120 x 125 with 75 mm	-	-
Light source		Semiconductor laser < 1 mW, 670 nm (red) with laser class 2 Semiconductor laser $\leq 5$ mW, 658 nm (red) with laser class 3R							
Laser class		Class 2 according to IEC 60825-1: 2014 optionally class 3R according to IEC 60825-1: 2014							
Permissible ambient light		50,000 lx					30,000 lx	10,000 lx	
Supply voltage		11 ... 30 V DC or PoE, external supply has priority over PoE							
Power consumption		< 3 W (24 V)							

Model	ILD1900-	2-IE	6-IE	10-IE	25-IE	50-IE	100-IE	200-IE	500-IE
Signal input	Laser on/off								
Digital interface	EtherCAT								
Connection	integrated pigtail 0.3 m with 12-pin M12 plug; optional extension to 3 m / 6 m / 9 m / 15 m (see accessories for suitable connection cable)								
Temperature range	Storage	-20 ... +70°C (non-condensing)							
	Operation	0 ... +50°C (non-condensing)							
Shock (DIN EN 60068-2-27)	15 g / 6 ms								
Vibration (DIN EN 60068-2-6)	30 g / 20 ... 500 Hz								
Protection class (DIN EN 60529)	IP67								
Material	Aluminum housing								
Weight	approx. 185 g (incl. pigtail)								
Control and indicator elements	Select button: factory setting, change operation mode; Web interface for setup <sup>5</sup> : Application-specific presets; peak selection, video signal; freely selectable averaging possibilities; data reduction; setup management; 3 color LEDs for power / status / EtherCAT								

FSO = Full Scale Output

SMR = Start of measuring range, MMR = Mid of measuring range, EMR = End of measuring range

The specified data apply to a white, diffuse reflecting surface (Micro-Epsilon reference ceramic for ILD sensors)

1) Factory setting: measuring rate 4 kHz, median 9;

2) Typical value with measurements at 4 kHz and median 9

3) In the mid of the measuring range; the specified value is only achieved by mounting on a metallic sensor holder. Good heat dissipation from the sensor to the holder must be ensured.

4) Light spot diameter determined using a point-shaped laser with Gaussian fit (full  $1/e^2$  width); for ILD1900-2: determined with emulated 90/10 knife-edge method

5) Connection to PC via network cable and sensor in Ethernet setup mode

## 3.3.2 ILD1900-xxLL

Model	ILD1900-	2LL-IE	6LL-IE	10LL-IE	25LL-IE	50LL-IE
Measuring range		2 mm	6 mm	10 mm	25 mm	50 mm
Start of measuring range		15 mm	17 mm	20 mm	25 mm	40 mm
Mid of measuring range		16 mm	20 mm	25 mm	37.5 mm	65 mm
End of measuring range		17 mm	23 mm	30 mm	50 mm	90 mm
Measuring rate <sup>1</sup>		continuously adjustable between 0.25 ... 10 kHz; 7 adjustable stages: 10 kHz / 8 kHz / 4 kHz / 2 kHz / 1.0 kHz / 500 Hz / 250 Hz				
Linearity		< ±1 μm	< ±1.2 μm	< ±2 μm	< ±5 μm	< ±10 μm
		< ± 0.05 % FSO	< ± 0.02 % FSO	< ± 0.02 % FSO	< ± 0.02 % FSO	< ± 0.02 % FSO
Repeatability <sup>2</sup>		< 0.1 μm	< 0.25 μm	< 0.4 μm	< 0.8 μm	< 1.6 μm
Temperature stability <sup>3</sup>		±0.005 % FSO / K				
Light spot diameter (± 10 %) <sup>4</sup>	SMR	55 x 480 μm	100 x 600 μm	125 x 730 μm	210 x 950 μm	235 x 1280 μm
	MMR	40 x 460 μm	50 x 565 μm	55 x 690 μm	80 x 970 μm	125 x 1500 μm
	EMR	55 x 440 μm	100 x 525 μm	125 x 660 μm	220 x 1000 μm	325 x 1470 μm
	smallest diameter	40 x 460 μm with 16 mm	50 x 565 μm with 20 mm	55 x 690 μm with 25 mm	80 x 970 μm with 37.5 mm	115 x 1450 μm with 59 mm
Light source		Semiconductor laser < 1 mW, 670 nm (red) with laser class 2 Semiconductor laser ≤ 5 mW, 658 nm (red) with laser class 3R				
Laser class		Class 2 according to IEC 60825-1: 2014 optionally class 3R according to IEC 60825-1: 2014				
Permissible ambient light		50,000 lx				
Supply voltage		11 ... 30 VDC or PoE, external supply has priority over PoE				
Power consumption		< 3 W (24 V)				

<b>Model</b>	<b>ILD1900-</b>	<b>2LL-IE</b>	<b>6LL-IE</b>	<b>10LL-IE</b>	<b>25LL-IE</b>	<b>50LL-IE</b>
Signal input	Laser on/off					
Digital interface	EtherCAT					
Connection	integrated pigtail 0.3 m with 12-pin M12 plug; optional extension to 3 m / 6 m / 9 m / 15 m (see accessories for suitable connection cable)					
Temperature range	Storage	-20 ... +70 °C, non-condensing				
	Operation	0 ... +50 °C, non-condensing				
Shock (DIN EN 60068-2-27)	15 g / 6 ms in 3 axes					
Vibration (DIN EN 60068-2-6)	30 g / 20 ... 500 Hz					
Protection class (DIN EN 60529)	IP67					
Material	Aluminum housing					
Weight	approx. 185 g (incl. pigtail)					
Control and display elements	Select button: factory setting, change operation mode; Web interface for setup <sup>5</sup> : Application-specific presets; peak selection, video signal; freely selectable averaging possibilities; data reduction; setup management; 3 color LEDs for power / status / EtherCAT					

FSO = Full Scale Output, SMR = Start of measuring range, MMR = Mid of measuring range, EMR = End of measuring range  
The specified data apply to white, diffuse reflecting surfaces (Micro-Epsilon reference ceramic for ILD sensors)

- 1) Factory setting: measuring rate 4 kHz, median 9;
- 2) Typical value with measurements at 4 kHz and median 9
- 3) In the mid of the measuring range; the specified value is only achieved by mounting on a metallic sensor holder. Good heat dissipation from the sensor to the holder must be ensured.
- 4) Light spot diameter with line-shaped laser determined based on the emulated 90/10 knife-edge method
- 5) Connection to PC via network cable and sensor in Ethernet setup mode

## 4. Delivery

### 4.1 Unpacking, Included in Delivery

- 1x ILD1900-x-IE sensor
- 1 Assembly Instructions
- 1 Calibration protocol
- Accessories (2 pc. centering sleeves, 2 pc. M3 x 40)

- ➡ Carefully remove the components of the measuring system from the packaging and ensure that the goods are forwarded in such a way that no damage can occur.
- ➡ Check the delivery for completeness and shipping damage immediately after unpacking.
- ➡ If there is damage or parts are missing, immediately contact the manufacturer or supplier.

Optional accessories are listed in the appendix see Chap. [A 1](#).

### 4.2 Storage

Temperature range for storage: -20 ... +70 °C

Humidity: 5 - 95% (non-condensing)

## 5. Assembly

### 5.1 Notes for Operation

#### 5.1.1 Reflectance of Target Surface

In principle, the sensor evaluates the diffuse portion of the reflections of the laser light spot.

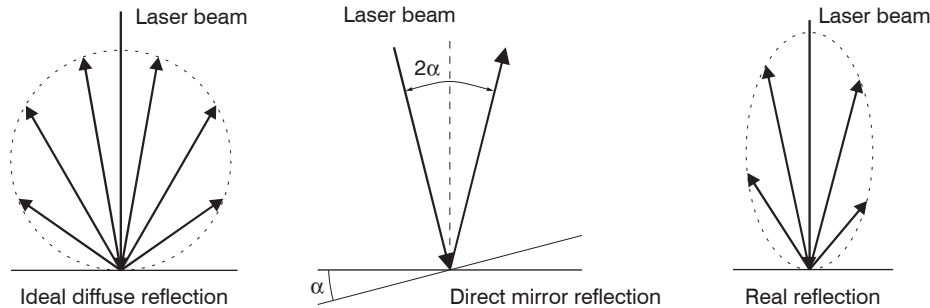

*Fig. 8 Reflectance of target surface*

Any statement about a minimum reflection factor is only possible with reservations, since small diffuse portions can be evaluated even of reflecting surfaces. This happens based on intensity determination of the diffuse reflection from the CMOS signal in real time and subsequent control, see Chap. 3.2. However, for dark or shiny measuring objects, such as black rubber, a longer exposure time may be required. The maximum exposure time is coupled to the measuring rate and can only be increased by lowering the measuring rate of the sensor.

## 5.1.2 Interferences

### 5.1.2.1 Ambient Light

Thanks to their integrated optical interference filters, the optoNCDT 1900 laser-optical sensors offer outstanding performance in suppressing ambient light. However, ambient light disturbances can occur with shiny measuring objects and at a reduced measuring rate. In these cases it is recommended to provide shielding against ambient light or to switch on the `Background suppression` function. This applies in particular to measurement work performed in the vicinity of welding devices.

### 5.1.2.2 Color Differences

Because of intensity compensation, color difference of targets affect the measuring result only slightly. However, such color differences are often combined with different penetration depths of the laser light into the material. Different penetration depths then result in apparent changes of the measuring spot size. Therefore color changes in combination with penetration depth changes may lead to measurement uncertainties.

### 5.1.2.3 Thermal Influences

When the sensor is commissioned, a warm-up time of at least 20 minutes is required to achieve uniform heat distribution in the sensor. If measurement is performed in the  $\mu\text{m}$  accuracy range, the effect of temperature fluctuations on the sensor holder must be considered.

Rapid temperature changes are not detected immediately due to the damping effect of the sensor's heat capacity.

### 5.1.2.4 Mechanical Vibrations

If a high degree of resolution in the  $\mu\text{m}$  range is required, the sensor and target must be mounted on a stable surface that is damped against vibrations.

### 5.1.2.5 Motion Blur

Fast moving targets and a low measuring rate may also cause motion blurring. Therefore, always select a high measuring rate for high-speed operations to prevent errors.



### 5.1.2.6 Surface Roughness

Laser-optical sensors detect the surface using an extremely small laser spot. They also track slight surface unevenness. In contrast, a tactile, mechanical measurement, e.g. using a caliper, detects a much larger area of the measuring object. In case of traversing measurements, surface roughnesses of  $5\ \mu\text{m}$  and more lead to an apparent distance change.

A suitable averaging number may improve the comparability of optical and mechanical measurements.

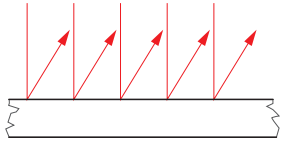

Ceramic reference surface

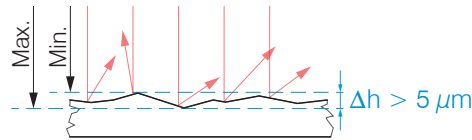

Structured surface

Recommendation for parameter choice:

- The averaging number should be selected in such a way that a surface area the size of which is comparable to those with mechanical measurements is averaged.

### 5.1.2.7 Angular Influences

Target tilt angles around both the X and Y-axis of less than  $5^\circ$  in the case of diffuse reflection only cause problems with surfaces that produce strong direct reflection.

These influences must be taken into account especially when scanning profiled surfaces. In principle, angular behavior of triangulation is also subject to the reflective properties of the target surface.

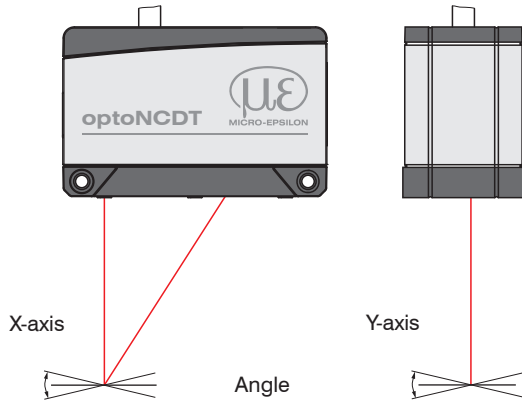
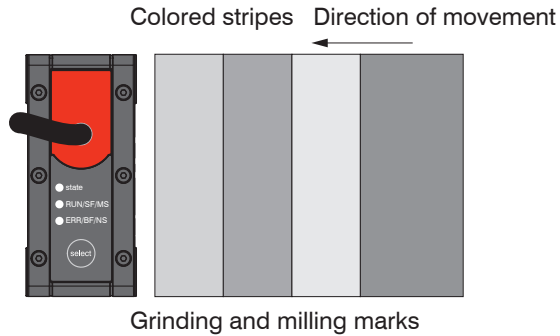

Fig. 9 Measurement error caused by tilt angle with diffuse reflection

### 5.1.3 Optimizing the Measurement Accuracy



In case of rolled or polished metals that are moved past the sensor, the sensor plane must be arranged in the direction of the rolling or grinding marks. The same arrangement must be used for color stripes.

*Fig. 10 Sensor arrangement for ground or striped surfaces*

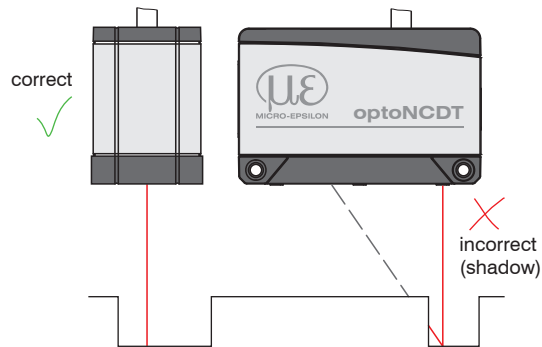

In case of bore holes, blind holes and edges in the surface of moving parts, the sensor must be arranged in such a way that the edge does not obscure the laser spot.

*Fig. 11 Sensor arrangement for holes and edges*

## 5.2 Mechanical Fastening, Dimensional Drawing

### 5.2.1 General

The optoNCDT 1900 sensor is an optical system used to measure in the micrometer range. If the laser beam does not strike the object surface at a perpendicular angle, measurements might be inaccurate.

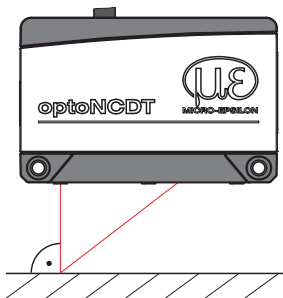

**i** Ensure careful handling of the sensor during installation and operation. Mount the sensor only to the existing through-bores on a flat surface. Any type of clamping is not permitted. Do not exceed torques.

The bearing surfaces surrounding the through-holes (fastening holes) are slightly raised.

Fig. 12 Sensor mounting with diffuse reflection

### 5.2.2 Mounting

Depending on the installation position, it is recommended to define the sensor position using centering elements and fitting bores. The cylindrical counterbore  $\varnothing 6$  H7 is intended for the position-defining centering elements. This allows for the sensor to be mounted in a reproducible and exchangeable way.

#### Bolt connection

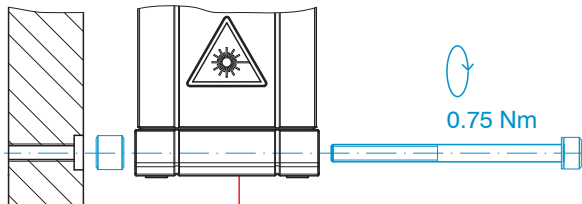

M3 x 40; ISO 4762, A2-70

#### Direct fastening

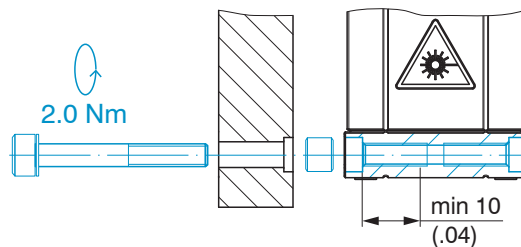

M4; ISO 4762, A2-70

Screwing depth min. 10 mm

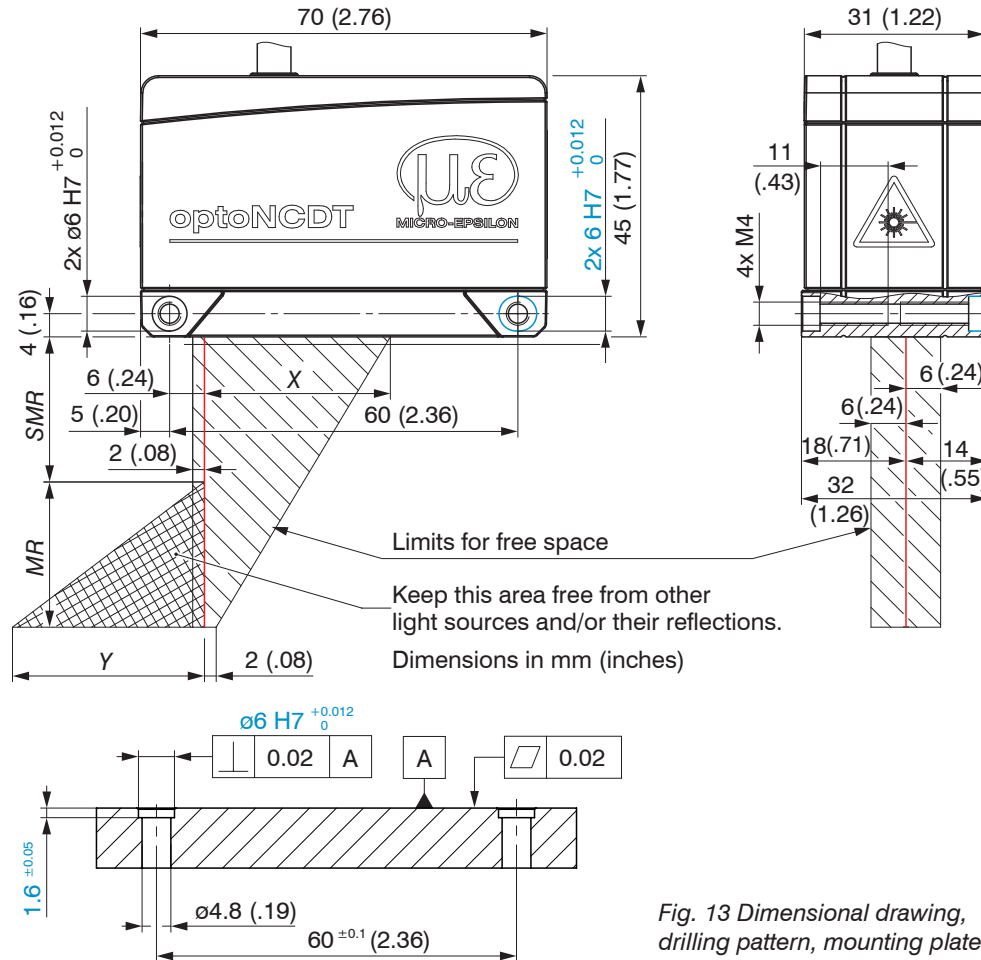

Fig. 13 Dimensional drawing, drilling pattern, mounting plate

**i** Mount the sensor only to the existing through-bores on a flat surface or screw it directly. Any type of clamping is not permitted.

MR	SMR	X	Y
2/2LL	15	23	3
6/6LL	17	27	9
10/10LL	20	33	14
25/25LL	25	33	33
50/50LL	40	36	45
100	50	37	75
200	60	39	130
500	100	43	215

Dimensions in mm

MR = Measuring range

SMR = Start of measuring range

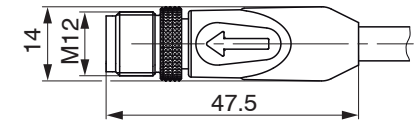
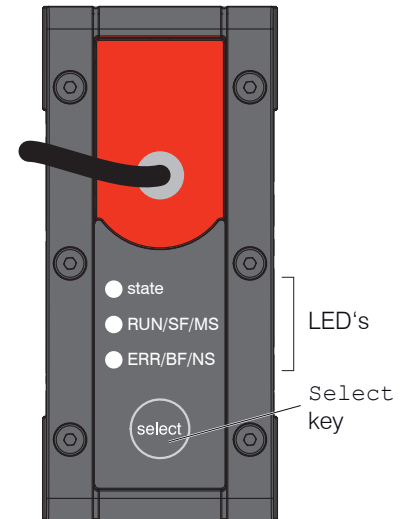

Fig. 14 Dimensional drawing of plug and sensor cable

### 5.3 Control and Indicator Elements

State LED	Meaning
Green	Measuring object within the measuring range
Yellow	Measuring object in the mid of the measuring range
Red	No distance value available, e.g. target outside the measuring range, too low reflection
Yellow flashing, 1 Hz	Bootloader
Yellow flashing, 8 Hz	Installation active
Yellow (briefly), red, yellow, green, off, alternating	Ethernet setup mode
Off	Laser switched off
LED RUN/SF/MS	Meaning
	According to EtherCAT mode
LED ERR/BF/NS	Meaning
	According to EtherCAT mode

Select button	Meaning
	<ul style="list-style-type: none"> <li>- Switch of operating mode</li> <li>- Reset to factory setting</li> </ul>



## 5.4 Electrical Connections

### 5.4.1 RJ45, PoE Connections

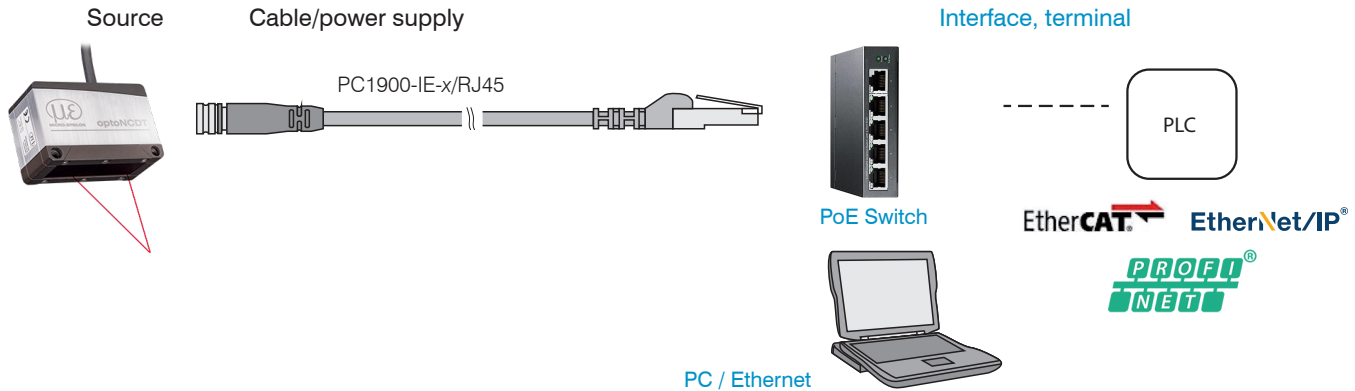

Fig. 15 ILD1900-IE connection example, laser on/off via software

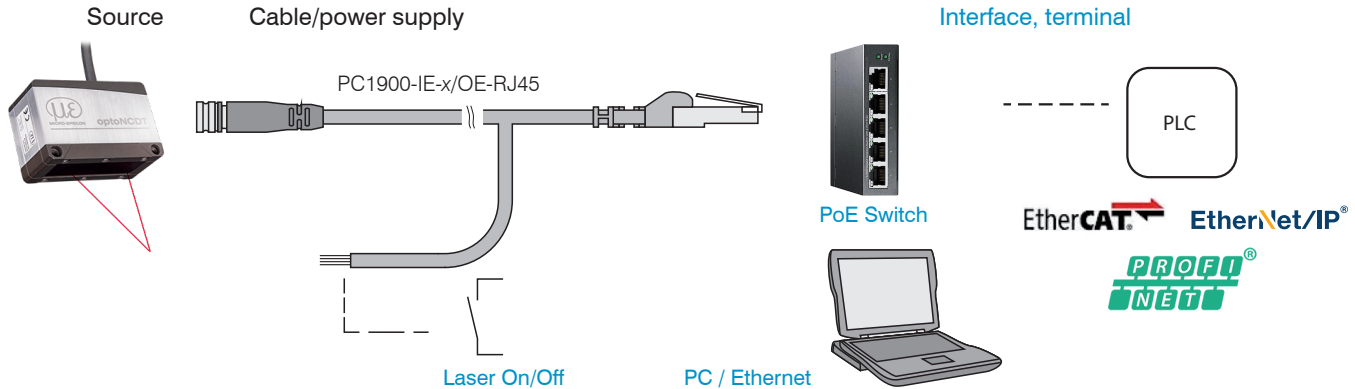

Fig. 16 ILD1900-IE connection example, laser on/off via hardware  
optoNCDT 1900 / EtherCAT

### 5.4.2 RJ45 Connection

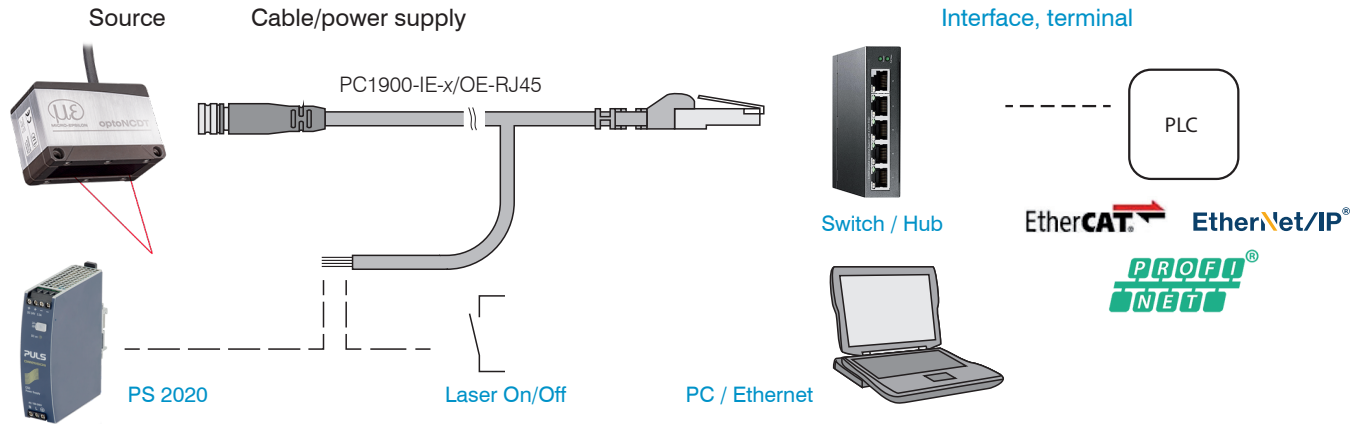

Fig. 17 ILD1900-IE connection example, supply via optional power supply unit, laser on/off via hardware



### 5.4.3 Pin Assignment

Signal	Wire color PC1900-IE-x/OE-RJ45	Comments	
V <sub>+</sub>	Red	Power supply	11 ... 30 VDC, typ. 24 VDC
GND	Blue	Reference ground	
Laser on/off +	Black	Switching input	Laser in the sensor is active if both pins are connected to each other.
Laser on/off -	Violet		

Fig. 18 Open end connections, PC1900-IE-x/OE-RJ45

Signal	Pin	Comments	11 ... 30 VDC, typ. 24 VDC	
V <sub>+</sub>	1	Power supply		
GND	2	Reference ground		
Laser on/off +	7	Switching inputs		
Laser on/off -	8			

Fig. 19 Pigtail connection on the sensor

### 5.4.4 Supply Voltage

Nominal value: 24 V DC (11 ... 30 V, P < 3 W).

EtherCAT with PoE	EtherCAT without PoE												
<p>Sensor supply is via a PoE-capable switch. Phantom powering (PoE) is possible via the</p> <ul style="list-style-type: none"> <li>- PC1900-IE-x/RJ45 or</li> <li>- PC1900-IE-x/OE-RJ45 cables.</li> </ul>	<p>Sensor supply is via the PC1900-IE-x/OE-RJ45 cable.</p>												
		<table border="1"> <thead> <tr> <th>Sensor Pin</th> <th>PC1900-IE-x/OE-RJ45 Color</th> <th>Power supply</th> </tr> </thead> <tbody> <tr> <td>1</td> <td>Red</td> <td>V<sub>+</sub></td> </tr> <tr> <td>2</td> <td>Blue</td> <td>GND</td> </tr> </tbody> </table>	Sensor Pin	PC1900-IE-x/OE-RJ45 Color	Power supply	1	Red	V <sub>+</sub>	2	Blue	GND		
	Sensor Pin	PC1900-IE-x/OE-RJ45 Color	Power supply										
1	Red	V <sub>+</sub>											
2	Blue	GND											
<p>As an alternative to PoE, the sensor can be supplied with the optional PS2020 power supply unit see <a href="#">Fig. 17</a>.</p>													
<p>Voltage supply only for measuring devices, not to be used for drives or similar sources of impulse interference at the same time. MICRO-EPSILON recommends using an optional available power supply unit PS2020 for the sensor.</p>													
<p>➡ Only turn on the power supply after wiring has been completed.</p>													
<p>➡ Connect the inputs Pin 1 and Pin 2 at the sensor with a 24V power supply.</p>													

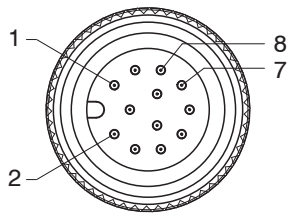
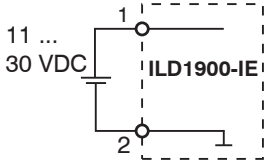
### 5.4.5 Turning on the Laser

The measuring laser on the sensor is switched on via a software command or a switching input. This allows to switch off the sensor for maintenance purposes or similar. Response time: after the laser is switched on, the sensor needs depending on the measuring rate 5 cycles to send correct measured data.

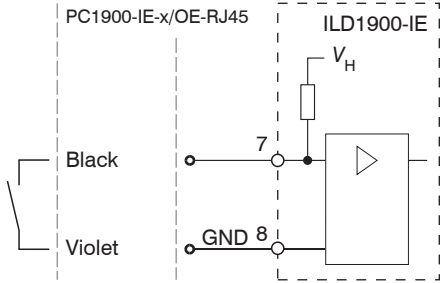
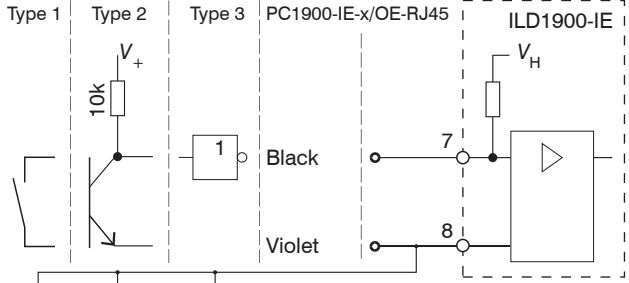
<p><b>Laser on/off via software, Supply with PoE</b></p> <p>The measuring laser on the sensor is activated via a software command.</p>	<p><b>Laser on/off via hardware, Supply with PoE</b></p> <p>The measuring laser on the sensor is activated via a switch or similar.</p>	<p><b>Laser on/off via hardware, Supply without PoE</b></p> <p>A switching transistor with open collector (for example in an optocoupler), a relay contact or a digital TTL or HTL signal are suitable for switching.</p>
<p>Activation using the PC1900-IE-x/RJ45 cable is possible.</p>	<p>Activation using the PC1900-IE-x/OE-RJ45 possible.</p> 	<p>Activation using the PC1900-IE-x/OE-RJ45 possible.</p>  <p>The inputs are not electrically separated.          24 V logic (HTL): Low level <math>\leq 3</math> V; High level <math>\geq 8</math> V (max 30 V)          internal pull-up resistor, an open input is detected as High.          Max. switching frequency 10 Hz.          The ground of the logic circuit must be galvanically connected to "Laser on/off -".</p> <p>No external resistance is required for current limitation. For permanent "Laser on", connect the black and violet wires.</p>

### 5.4.6 Plug-In Connection, Supply and Output Cable

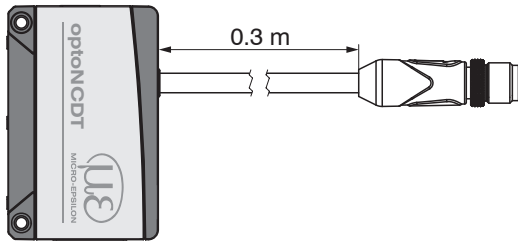

ILD1900-IE with pigtail

- ▶ Do not bend the sensor cable more tightly than 30 mm (fixed installation) or 75 mm (permanently flexible).
- i The firmly connected sensor cable is drag-chain suitable.
- i Unused open cable ends must be insulated to protect against short circuits or sensor malfunctions.

MICRO-EPSILON recommends the use of the PC1900-IE drag-chain compatible standard connection cables from the optional accessories see Chap. [A 1](#).

- ▶ Fasten the plug connection of the cable plug and socket when using a drag-chain compatible PC1900-IE sensor cable.
- ▶ Avoid excessive pull on the cables. If a cable of over 5 m in length is used and it hangs vertically without being secured, make sure that some form of strain relief is provided close to the plug connection.
- ▶ Do not twist a mated connection.
- ▶ Connect the cable shield to the potential equalization (PE, protective earth conductor) on the evaluator (control cabinet, PC housing) and avoid ground loops.
- ▶ Never lay signal lines next to or together with power cables or pulse-loaded cables (e.g., for drives or solenoid valves) in a single bundle or duct. Always use separate ducts.

## 6. Operation

### 6.1 Getting Ready for Operation

- ▶ Mount the optoNCDT 1900 according to the assembly instructions, see Chap. 5.
- ▶ Connect the sensor to the downstream display or monitoring units and to the voltage supply, if no PoE is used.

The laser diode in the sensor is only activated

- due to software command or
- if the black and violet wires of the PC1900-IE-x/OE-RJ45 are connected, see Chap. 5.4.5.

Once the power supply has been switched on, the sensor runs through an initialization sequence. Already within the first second a connection to the sensor can be established and the measurement can be started.

During the first three seconds, an internal function check in the sensor is indicated by the Status LED, which lights up in the colors red, yellow and green one after another.

Initialization takes a maximum of 3 seconds. Within this period, only the reset or the bootloader command is executed via the `Select` button.

The sensor typically requires a warm-up time of 20 min for reproducible measurements.

If the `State` LED is off, the laser light source has been switched off.

If all LEDs are off, no power is being supplied.

## 6.2 Operation via Web Interface, Ethernet

### 6.2.1 General

The sensors start with the last stored operating mode. Standard is EtherCAT. Access via Ethernet is possible in the Ethernet setup mode. Alternatively, Ethernet data traffic can also be tunneled via EtherCAT (EoE).

A web server is implemented in the sensor; the web interface displays, among other things, the current settings of the sensor. Operation is only possible while there is an Ethernet connection to the sensor.

➡ Choose between the two following operation modes.

#### Ethernet setup mode

➡ Switch to the Ethernet setup mode.

Please refer to the section `Switching between EtherCAT and Ethernet Setup Mode` for details.

The standard IP address is 169.254.168.150. Note: As IP setting of the network card to which the sensor is connected, we recommend a static configuration with 169.254.168.1 as IP address and the subnet mask 255.255.0.0.

➡ Start your web browser and type the IP address of the sensor into the address bar.

In addition to the web page, you can also install new firmware via Ethernet using the firmware update tool.

#### Ethernet over EtherCAT (EoE)

Parallel to the EtherCAT operation you can adjust the sensor.

➡ Enable EoE in your PLC software.

`Virtual Ethernet Port` is a name in TwinCAT®.

➡ Assign a MAC address and an IP address to the slave.

If EoE is enabled, you can also install a new firmware via the firmware update tool.

## 6.2.2 Access via Web Interface

▶ Start the sensor web interface, see Chap. 6.2.1.

Interactive web pages you can use to configure the sensor are now displayed in the web browser. The sensor is active and supplies measurement values. Real-time measuring is not guaranteed with the web interface. The currently running measurement can be controlled using the function buttons in the `chart` type.



The horizontal navigation includes the functions below:

- The search function permits time-saving access to functions and parameters.
- Home. The web interface automatically starts the measurement view, Signal quality and Configurations.
- Measurement configuration. Allows a selection of predefined measurement settings.
- Settings. Configuration of the sensor parameters see Chap. 7.
- Measurement chart. Measurement chart or video signal display.
- Info. Includes information about the sensor, such as measuring range, serial number and software status.

Fig. 20 First page after web interface has been accessed in Ethernet mode

For configuration, you can switch between the video signal and the display for the measured values. The appearance of the websites depends on the functions. Dynamic help text with excerpts from the operating instructions supports you during sensor configuration.

**i** Depending on the selected measuring rate and the PC used, measured values may be reduced in the display. This means that not all measured values are transmitted to the web interface for display and saving.

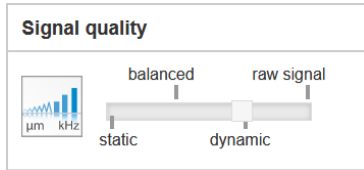

Averaging	Description
Balanced Median with 9 values + Moving with 64 values	<p>The <code>Signal quality</code> section enables to switch between four preset basic settings (Static, Balanced, Dynamic and without averaging). The effects are immediately displayed in the chart and the system configuration.</p> <p><b>i</b> If the sensor is started with a user-specific measurement setting (Setup), see Chap. 7.7.3, changing the signal quality is not possible.</p> <p>The Signal Quality function can be used to specify the predefined presets more precisely for the individual measurement task.</p>
Raw signal, without averaging	
Static Median with 9 values + Moving with 128 values	
Dynamic Median, 9 values	

**System configuration**

Hz kHz Measuring rate  
4.000 kHz

Averaging 1  
Median: 9

Averaging 2  
Inactive

RS422  
921.6 kbps: Distance 1

The `System configuration` section shows the current settings for Measuring rate, Averaging and RS422 in blue. You can change the settings via the `Signal Quality` slider or in the `Settings` tab.

The Chart Type area allows switching between the graphical representation of the measured values over time or the video signal.



**i** After parameterization, store all settings permanently in a parameter set so that they are available again the next time the sensor is switched on.

To do this, use the `Save settings` button.



### 6.2.3 Measurement Task Selection

Conventional measurement configurations (presets) for various target surfaces are saved in the sensor. This allows you to quickly start with your individual measurement task. Selecting a preset, which is suitable for the target surface activates a predefined configuration of settings that will produce the best results for the material selected.

Measuring task		
Selecting target characteristics		
 Standard	Standard	Ceramics, metal
 Changing surfaces	Changing surfaces <sup>1</sup>	PCBs, hybrid metal
 Material with penetration	Material with penetration <sup>1</sup>	Plastics (Teflon, POM), materials with strong penetration depth of the laser

1) Available for the ILD1900-2/6/10/25/50 sensor models

## 6.2.4 Display of Measurement Values in the Web Browser

► Display the measurement values in the Measurement chart tab.

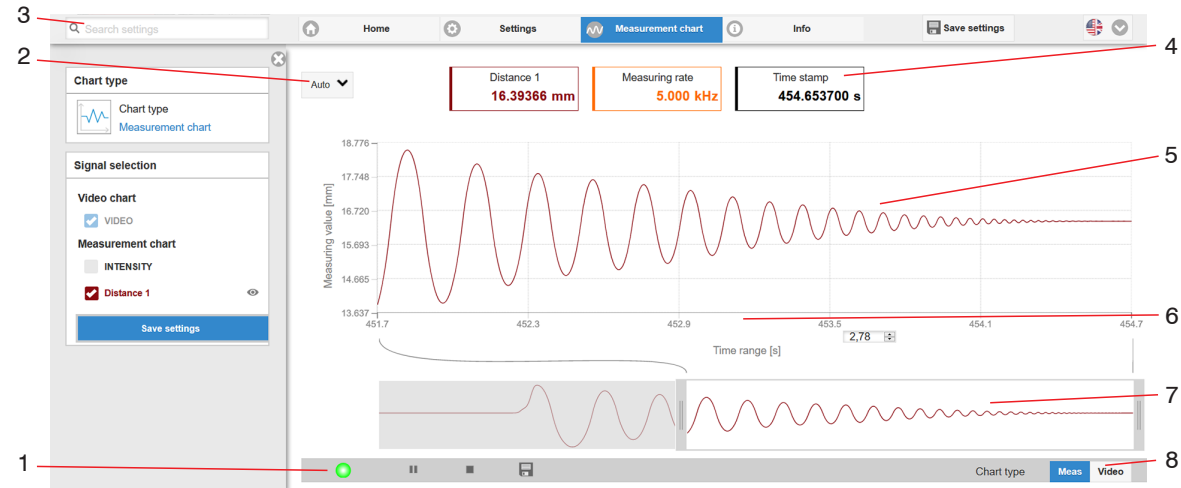

Fig. 21 Measurement (distance measurement) web page

- 1 The LED visualizes the status of the transmission of measured values:
  - green: transmission of measured values is running.
  - yellow: waiting for data in trigger mode
  - gray: transmission of measured values stopped

Data queries are controlled by using the **Play/Pause/Stop/Save** buttons of the measured values that were transmitted. **Stop** pauses the chart; you can still use the data selection and zoom functions. **Pause** stops the recording. **Save** opens the Windows selection dialog for the file name and storage location to save the last 10,000 values in a CSV file (separation using semicolon).

► Click the ► button (Start) to display the measurement results.

- 2 To scale the axis in the graph for the measured values (y-axis), you can use `Auto` (= automatic scaling) or `Manual` (= manual scaling).
- 3 The search function permits time-saving access to functions and parameters.
- 4 The text boxes above the graphic display the current values for distance, exposure time, current measuring rate, display rate and time stamp.
- 5 Mouseover function. When the chart has been stopped and you move the mouse over the graph, points on the curve are marked with a circle and the associated values are displayed in the text boxes above the graph. Peak intensity is also updated.
- 6 The x-axis can be scaled in the input field under the time axis.
- 7 Scaling the x-axis: During an ongoing measurement, you can use the left-hand slider to enlarge the entire signal (zoom). When the chart has been stopped, the right-hand slider can also be used. You can also move the zoom window with the mouse in the center of the zoom window (four-sided arrow).
- 8 Select a chart type: measurement values or video signal

### 6.2.5 Video Signal Display in the Web Browser

➡ Display the video signal in the Video section of the Chart type selection.

The graph displayed in the large chart area on the right represents the video signal and the receiving row. The video signal displayed in the chart area displays the intensity distribution of the pixels in the receiving row. Left 0 % (short distance), and right 100 % (large distance). The corresponding measurement value is marked by a vertical line (peak marking).

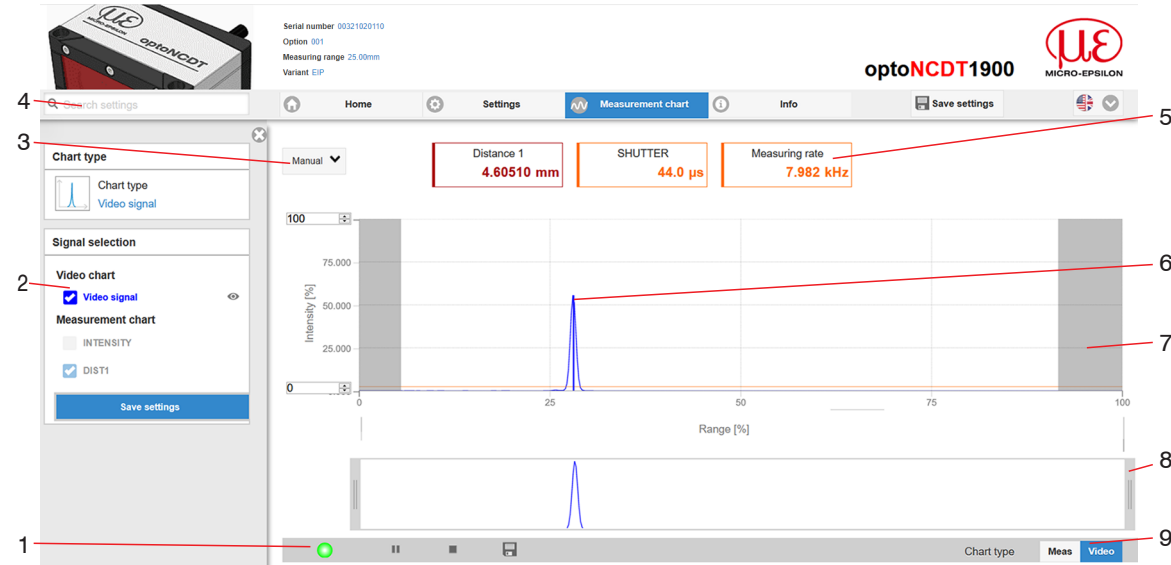

Fig. 22 Video signal web page

1 The LED visualizes the status of the transmission of measured values:

- green: transmission of measured values is running.
- yellow: waiting for data in trigger mode
- gray: transmission of measured values stopped

Data queries are controlled by using the buttons `Play/Pause/Stop/Save` the measured values that were transmitted. `Stop` pauses the chart; you can still use the data selection and zoom functions. `Save` opens a Windows selection dialog for the file name and storage location to save the video signal in a CSV file.

 Click on the  button (Start) to display the video signal.

2 In the left-hand window, the video channels to be displayed can be switched on or off during or after the measurement. Inactive curves are grayed out and can be added by clicking on the check mark. If you want to have displayed one single signal, click on its name.

- Peak marking (vertical blue line), corresponds to the evaluated measured value
- Linearized measuring range (limited by gray hatching), not changeable
- Masked range (limited by light blue hatching), changeable

3 To scale the intensity axis in the graph for the measured values (y-axis), you can use `Auto` (= automatic scaling) or `Manual` (= manual scaling).

4 The search function permits time-saving access to functions and parameters.

 ASCII commands to the sensor can also be entered directly in the search field.

5 The text boxes display the current values for distance, exposure time, current measuring rate, display rate and time stamp.

6 Mouseover function. When the chart has been stopped and you move the mouse over the graph, points on the curve are marked with a circle and the associated intensity is displayed. The corresponding x position is displayed in % above the graph window.

7 The linearized range is in the graph between the gray shadows and can not be changed. Only peaks of which the centers are in this range can be evaluated. The masked range may be limited if needed. Then an additional pale blue shadow limits the range on the right and on the left side. The peaks remaining in the resulting range are used for evaluation, see Chap. [7.4.4](#).

- 8 Scaling the x-axis: You can zoom into the graph shown above with the two sliders on the right and left in the lower overall signal section. You can also move it to the side with the mouse in the center of the zoom window (four-sided arrow).
- 9 Select a chart type: measurement values or video signal

The display shows how the adjustable measurement task (target material), peak selection and possible interfering signals due to reflections or similar affect the video signal. There is no linear relationship between the position of the peak in the video signal display and the output measured value.

### 6.3 Parameter Setting via EtherCAT

EtherCAT includes a mechanism for parameterizing the EtherCAT slaves. *Service Data Objects* (SDO) are defined for this purpose, which contain the parameters for configuring the sensor. For details about reading and changing SDO, please refer to the description of your EtherCAT master.

An overview of the available SDOs can be found in the appendix, see Chap. [A 5.3.2](#).

### 6.4 Timing, Measurement Value Cycles

The sensor needs five internal cycles for measuring and processing: The measurement value  $N$  is transmitted to the EtherCAT master in the fifth cycle.

Measurement, processing and transmission take place in parallel, so that the next measurement value ( $N+1$ ) is transmitted in the following cycle.

## 6.5 Operation via Membrane Key

The `Select` button

- starts the factory settings or
- the bootloader function.

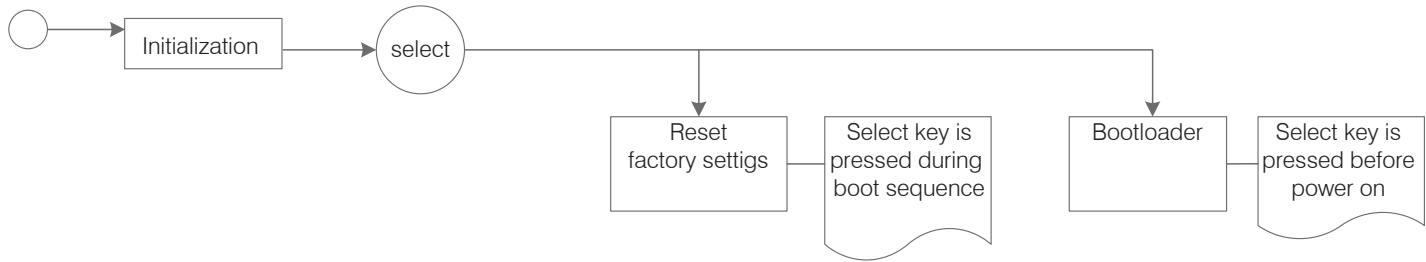

*Fig. 23 Process: calling up the factory settings or boot loader via `Select` button*

## 7. Setting Sensor Parameters

### 7.1 Preliminary Remarks about the Setting Options

There are two ways to parameterize the optoNCDT 1900:

- via web browser and sensor web interface,
- with EtherCAT via SDO, see Chap. [A 5.3.2](#).

**i** If you do not permanently save the parameter set in the sensor, the settings are lost when the sensor is turned off. If supported by the EtherCAT master, values for the SDO objects can be permanently stored in the EtherCAT master and transferred to the sensor when the system is started.

### 7.2 Parameters Overview

The following parameters can be set or changed in the optoNCDT 1900, see `Settings` tab.

Inputs	Laser power
Data recording	Measurement task, measuring rate, evaluation range, exposure mode, peak selection
Signal processing	Averaged measurement 1/2, zeroing/mastering
System settings	Web interface unit, Load & Save, Import & Export, Reset sensor (factory setting)





### 7.3 Inputs

➤ Change to the `Inputs` menu in the `Settings` tab.

Laser power	<i>Full</i>	<i>Full power for standard surfaces</i>	<i>The laser light source is only enabled if pin 7 is connected to pin 8, see Chap. 5.4.5.</i>
	<i>Medium</i>	<i>Optimized power for strongly reflecting surfaces and small measuring ranges</i>	
	<i>Reduced</i>	<i>Min. power for service purposes</i>	
	<i>Off</i>	<i>Laser is off</i>	
Synchronization with EtherCAT		<i>In case several sensors should measure the same target synchronously, you can synchronize the sensors with each other. Detailed information is available in the <code>Distributed Clocks</code> section, see Chap. A 5.8.2.</i>	

**i** Pay attention to the signal intensity when switching the laser power. You achieve best possible results with a signal intensity of 25 ... 50 %.

 Fields with gray background require a selection.

 *Value* Fields with dark border require entry of a value

## 7.4 Data Recording

### 7.4.1 Preliminary Remarks

➡ On the **Settings** tab, switch to the **Data recording** menu.

According to the previous setting in the **Chart type** area, a graph is displayed in the right part of the display. The diagram is active and all settings become immediately visible. Notes on the chosen settings are displayed below.

In the left area, the **Data recording** menus are displayed.

### 7.4.2 Measurement Configuration

For further details, see Chap. 6.2.3.

### 7.4.3 Measuring Rate

The measuring rate indicates the number of measurements per second.

➡ Select the required measuring rate.

Measuring rate	250 Hz / 500 Hz / 1 kHz / 2 kHz / 4 kHz / 8 kHz / 10 kHz	Use a high measuring rate for bright and mat measuring objects. Use a low measuring rate for dark or shiny measuring objects (e.g. black painted surfaces) to improve the measurement result.
	free measuring rate <input type="text" value="Value"/>	

At a maximum measuring rate of 10 kHz, the CMOS element is exposed 10,000 times per second. The lower the measuring rate, the longer the maximum exposure time.

The measuring rate is factory set to 4 kHz.

Fields with gray background require a selection.

Fields with dark border require entry of a value

### 7.4.4 ROI Masking

Masking limits the evaluating range (ROI - Region of Interest) for the distance calculation in the video signal. This function is used in order to e.g. suppress interfering reflections or ambient light.

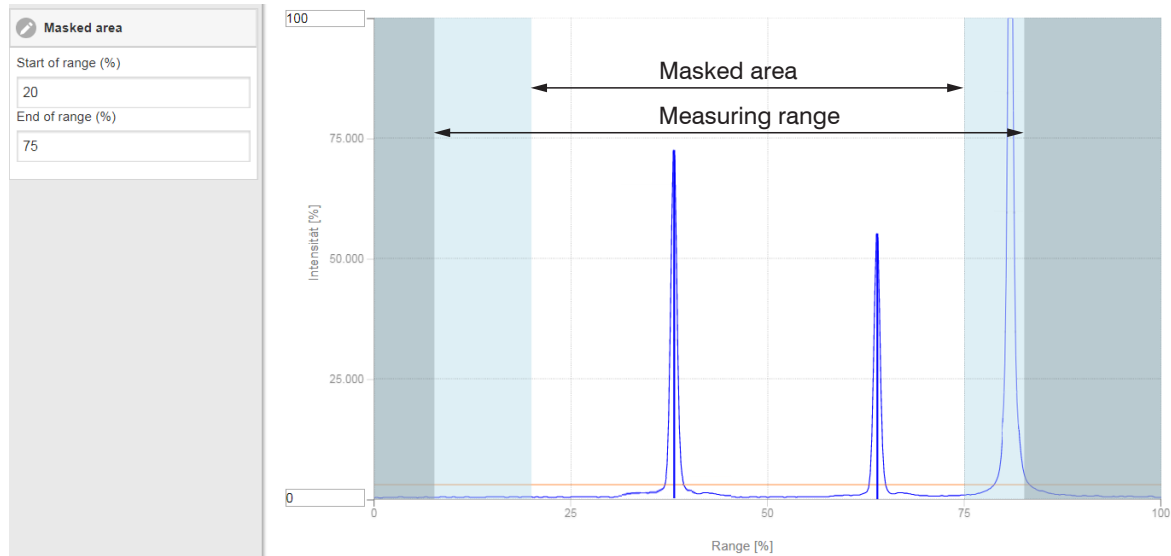



Fig. 24 Light-blue areas delimit the region of interest

The exposure control optimizes the peaks in the evaluation range. Therefore, small peaks can be optimally adjusted when a high interference peak is outside the evaluation range.

 Fields with gray background require a selection.

 *Value* Fields with dark border require entry of a value

7.4.5 Exposure Mode

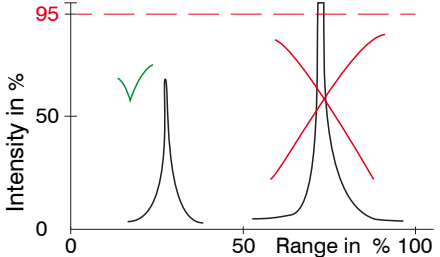
<p>Exposure mode</p>	<p><i>Automatic mode</i></p>	<p><i>Standard / Intelligent control / Background suppression</i></p>		 <p><i>Standard: The sensor itself determines the optimal exposure time. The sensor adjusts the signal intensity to approx. 50%.</i></p> <p><i>Intelligent control: This intelligent algorithm is particularly advantageous for measurements on moving objects or in the case of transitions between different materials.</i></p> <p><i>Background suppression: Suppresses interference caused by ambient light. This significantly improves the ambient light tolerance of the sensor. The output rate of the sensor is halved.</i></p>
	<p><i>Manuel mode</i></p>	<p>Exposure time in <math>\mu\text{s}</math></p>	<p>Value</p>	<p><i>In manual mode, with the video signal shown, the exposure time is set by the user. Vary the exposure time in order to obtain a signal intensity of up to 95%.</i></p>

 Fields with gray background require a selection.

 Value Fields with dark border require entry of a value

### 7.4.6 Peak Selection

Peak selection	<i>First Peak / Highest Peak / Last Peak / Widest Peak</i>	<p><i>Defines which signal in the array signal is used for the evaluation.</i></p> <p><i>First peak: Nearest peak to sensor.</i></p> <p><i>Highest peak: Standard, peak with the highest intensity.</i></p> <p><i>Last peak: Peak furthest away from sensor.</i></p> <p><i>Largest peak: Peak with the largest surface.</i></p>	
----------------	--	---	--

If a measuring object contains multiple transparent layers, a correct measurement result is determined only for the first peak.



Fields with gray background require a selection.



Value Fields with dark border require entry of a value

## 7.5 Signal Processing

### 7.5.1 Preliminary Remarks

➡ Change to the `Signal processing` menu in the `Settings` tab.

According to the previous setting in the `Chart type` area, a graph is displayed in the right part of the display. The graph is active and all settings become immediately visible. Notes on the chosen settings are displayed below.

In the left area, the `Signal processing` menus are displayed.

### 7.5.2 Averaging

#### 7.5.2.1 General

Averaging is recommended for static measurements or slowly changing measurement values. The `Averaging 1` function is executed before the `Averaging 2` function.

Measurement averaging	<i>No averaging</i>			<i>No measurement value averaging.</i>
	<i>Moving N values</i>	2 / 4 / 8 ... 4096	Value	<i>Specify the type of averaging. The averaging number N indicates how many consecutive values are averaged in the sensor.</i>
	<i>Recursive N values</i>	2 ... 32767	Value	
	<i>Median N values</i>	3 / 5 / 7 / 9	Value	

Measurement averaging is performed after the distance values have been calculated, and before they are issued through the relevant interfaces.

Averaging

- improves the resolution,
- allows masking individual interference points or
- "smoothes" the measurement result.

Linearity is not affected by averaging.

The average values are continuously recalculated with each measurement. The desired averaging depth is only achieved after the number of recorded measurement values corresponds at least to the averaging depth.

 Fields with gray background require a selection.

 Value Fields with dark border require entry of a value

**i** The defined type of average value and the averaging number must be stored in the sensor so that they are retained after switching off.

Averaging has no effect on the measuring rate or data rate in case of digital measurement value output. The averaging numbers can also be programmed via the digital interfaces. The optoNCDT 1900 sensor is delivered with “Median 9” as factory settings, i.e. median averaging over 9 measurement values.

Depending on the type of average and the number of averaged values, different transition response times result thereof, see Chap. 6.4.

### 7.5.2.2 Moving Average

The definable number  $N$  for successive measurements (window width) is used to calculate the arithmetic average  $M_{\text{mov}}$  according to the following formula:

$$M_{\text{mov}} = \frac{\sum_{k=1}^N MV(k)}{N}$$

$MV$	Measurement value,
$N$	Averaging number,
$k$	Running index
$M_{\text{mov}}$	Averaging value or output value

#### Method:

Each new measured value is added, the first (oldest) measured value is removed from the averaging (from the window) again. In this way, it is possible to achieve short transition response times with measured value jumps.

Example:  $N = 4$

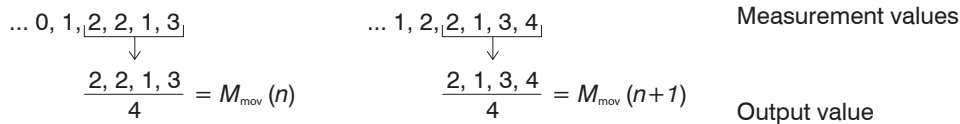

#### Note:

For the moving averaging in the optoNCDT 1900, only powers of 2 are permitted for the averaging number  $N$ . Range of values for the averaging number  $N$  is 1 / 2 / 4 / 8 ... 4096.

### 7.5.2.3 Recursive Average

Formula:

$$M_{\text{rec}}(n) = \frac{MV_{(n)} + (N-1) \times M_{\text{rec}(n-1)}}{N}$$

*MV* Measurement value,  
*N* Averaging number,  
*n* Measurement value index  
*Mrec* Averaging value or output value

#### Method:

The weighted value of each new measured value  $MV(n)$  is added to the sum of the previous average values  $M_{\text{rec}}(n-1)$ .

#### Note:

Recursive averaging enables very strong smoothing of the measured values, however it needs very long settling times for measured value jumps. The recursive average value shows low-pass behavior. The range of values for the averaging number  $N$  is 2 ... 32767.

### 7.5.2.4 Median

A median value is formed from a preselected number of measurements.

#### Methods:

The incoming measured values (3, 5, 7 or 9 measurement values) are also sorted again after each measurement. The median value is then output as the median. 3, 5, 7 or 9 measured values are taken into account for the calculation of the median, i.e. there is no median 1.

#### Note:

This averaging type suppresses individual interference pulses. However, the smoothing of the measured value curves is not very strong.

Example: mean value from five readings

... 0 1 2 4 5 1 3 → Sorted measurement values: 1 2 3 4 5 Median  $_{(n)} = 3$

... 1 2 4 5 1 3 5 → Sorted measurement values: 1 3 4 5 5 Median  $_{(n+1)} = 4$



### 7.5.3 Zeroing, Mastering

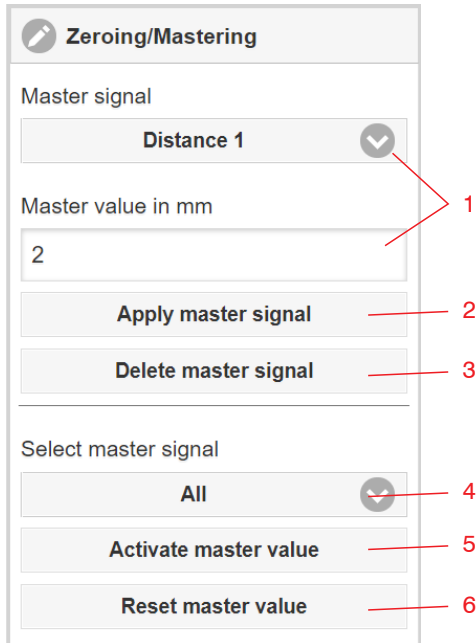

Use zeroing and setting masters to define a target value within the measuring range. This shifts the output range. This feature can be useful, for example, when several sensors carry out thickness and planarity measurements when placed next to one another or when replacing a sensor.

Mastering (setting masters) is used to compensate for mechanical tolerances in the sensor measurement setup or to correct chronological (thermal) changes to the measuring system. The master value, also called calibration value, is defined as the target value.

The master value is the reading that is issued as result of measuring a master object. Zeroing is when you set a master with 0 (zero) as the master value.

**i** Mastering or Zeroing requires a target object to be present in the measuring range.

Mastering or Zeroing equally influences the digital output and the display.

- 1 Selects a signal for the function, assigns master value
- 2 Saves master value in volatile memory. <sup>1</sup>
- 3 Deletes master value in volatile memory.
- 4 Selects a specific signal or function
- 5 Starts function
- 6 Ends function, returns to absolute measurement

#### Mastering / Zeroing:

- ➡ Place target and sensor into the desired positions.
- ➡ Send the Master command (EtherCAT) or click the `Activate master value` button.

After setting the master, the controller will issue new readings that relate to the master value. The `Reset master value` button resets the system to the state before mastering.

- 1) The `Save settings` function permanently saves the master value to a setup.

## 7.6 EtherCAT Digital Output

### 7.6.1 Values, Ranges

The digital measurement values are issued as unsigned digital values (raw values). 16 or 18 bits can be transferred per value. Below you will find a compilation of the output values and the conversion of the digital value.

Value	Length	Variables	Value range	Formula
Distance	18 Bit	<i>x</i> Digital value	[0; 230604]	$d = \frac{x - 98232}{65536} * MR$
		<i>MR</i> Measuring range in mm	{2/6/10/25/50/100/200/500}	
		<i>d</i> Distance in mm	without mastering [-0.01 <i>MR</i> ; 1.01 <i>MR</i> ] with mastering [-2 <i>MR</i> ; 2 <i>MR</i> ]	
Exposure time	16 Bit	<i>x</i> Digital value	[1000; 40000]	$ET = \frac{1}{10} x$
		<i>ET</i> Exposure time in $\mu$ s	[100; 4000]	
Intensity	16 Bit	<i>x</i> Digital value	[0; 1023]	$I = \frac{100}{1023} x$
		<i>I</i> Intensity in %	[0; 100]	
Sensor status	18 Bit	<i>x</i> Digital value	[0; 242143]	Bit 0 (LSB): Peak starts before ROI
		Bit coding	[0; 1]	Bit 1: Peak ends after ROI
				Bit 2: No peak found
		<i>SMR</i> Start of measuring range		Bit 5: Distance before <i>SMR</i> (extended)
		<i>EMR</i> End of measuring range		Bit 6: Distance after <i>EMR</i> (extended)
			Bit 15: Measurement value is triggered	
Measured value counter	18 Bit	<i>x</i> Digital value	[0; 262143]	

Timestamp	32 Bit	<i>x</i>	Digital value	[0; 4294967295]	$t = \frac{1}{1000} x$
		<i>t</i>	Time stamp in $\mu$ s	[0; 1h11m34.967s]	
Unlinearized center of gravity	18 Bit	<i>x</i>	Digital value	[0; 262143]	$US = \frac{100}{262143} x$
		<i>CG</i>	Center of gravity in %	[0; 100]	
Measurement frequency	18 Bit	<i>x</i>	Digital value	[2500; 100000]	$f = \frac{x}{10}$
		<i>f</i>	Frequency in Hz		

State information transferred in the distance value

Distance value	Description
262076	There is no peak present
262077	Peak is before measuring range (MR)
262078	Peak is after measuring range (MR)
262080	Measurement value cannot be evaluated
262081	Peak is too wide
262082	Laser is off

### 7.6.2 Behavior of the Digital Output

Master values based on the zeroing or master function are coded with 18 bits. The master can assume twice the measuring range. The examples demonstrate the behavior of the digital value with an ILD1900-100-IE, measuring range 100 mm.

Target with 16% of the measuring range

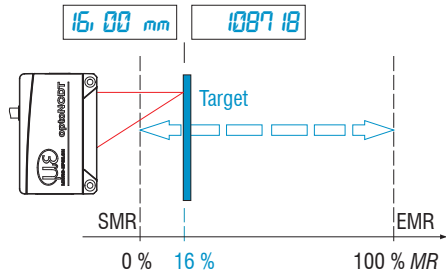

Target with 60% of the measuring range

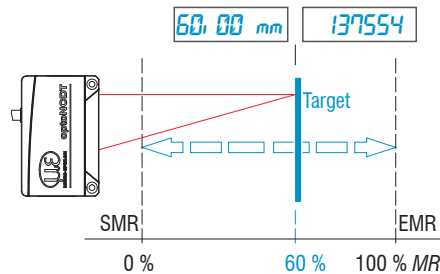

Target with 60% of the measuring range

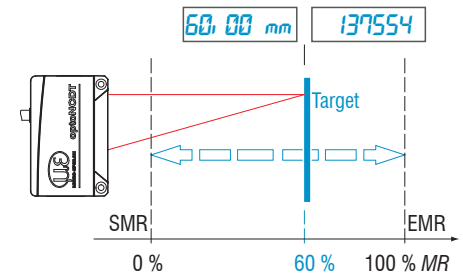

➡ Zero setting (master value = 0 mm)

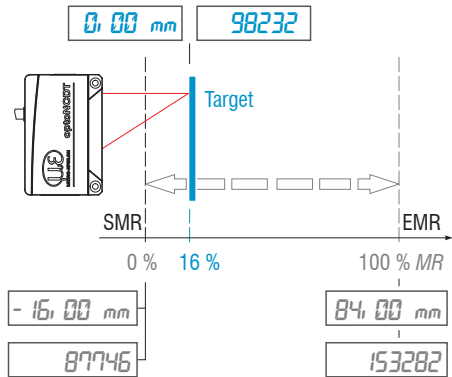

➡ Zero setting (master value = 0 mm)

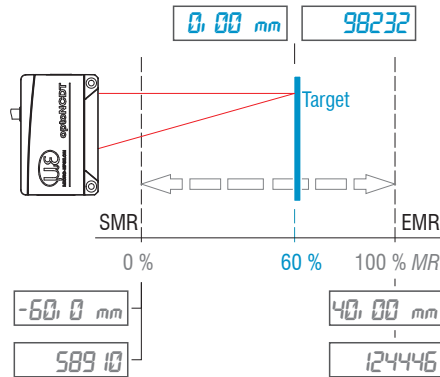

➡ Setting master value 10 mm

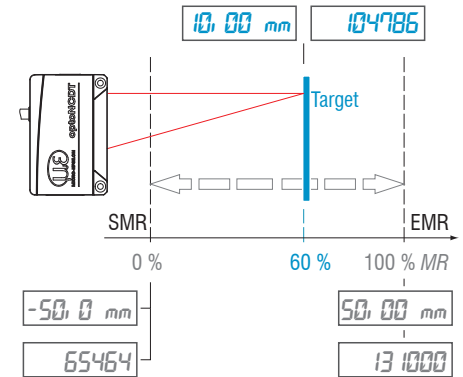

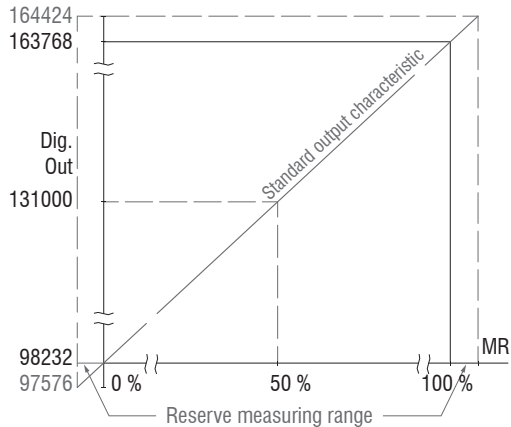

Fig. 25 Digital values without zeroing or mastering  
optoNCDT 1900 / EtherCAT

Target with 80% of the measuring range (80 mm)

➡ Setting master value 200 mm

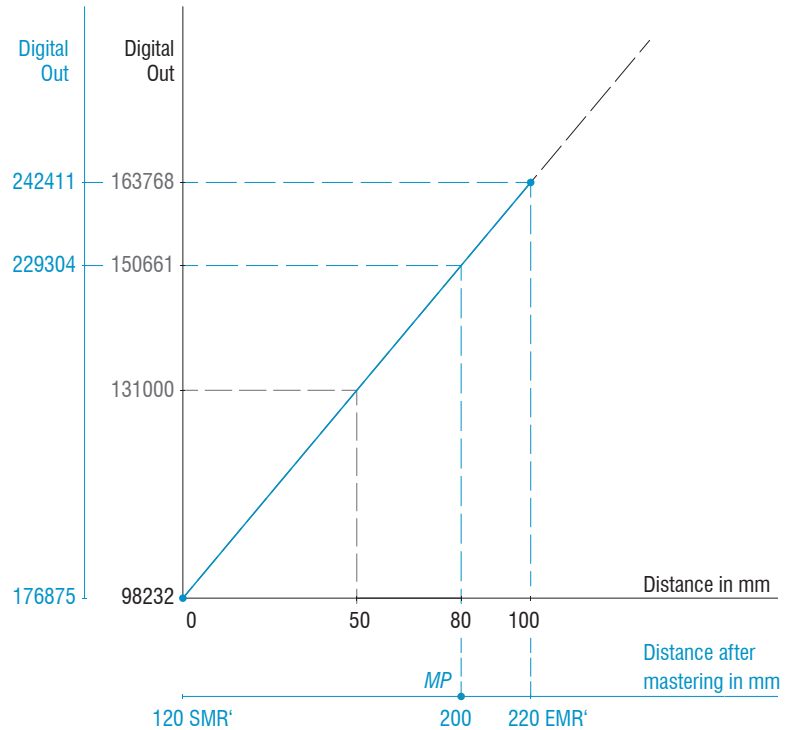

Fig. 26 Digital values 1900-100-IE after mastering with 200 mm master value

## 7.7 System Settings

### 7.7.1 General

After programming, save all settings permanently to a parameter set so that they will be available again the next time you switch on the sensor.

### 7.7.2 Unit, Language

The web interface promotes the units millimeter (mm) and inch when displaying measuring results. You can choose German or English in the web interface and change the language in the menu bar.

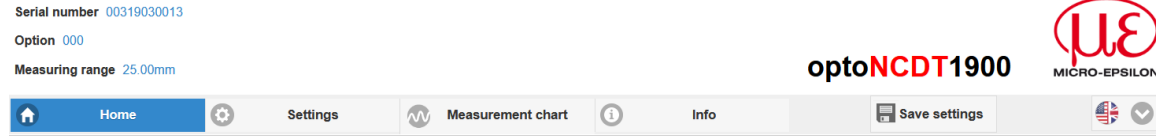
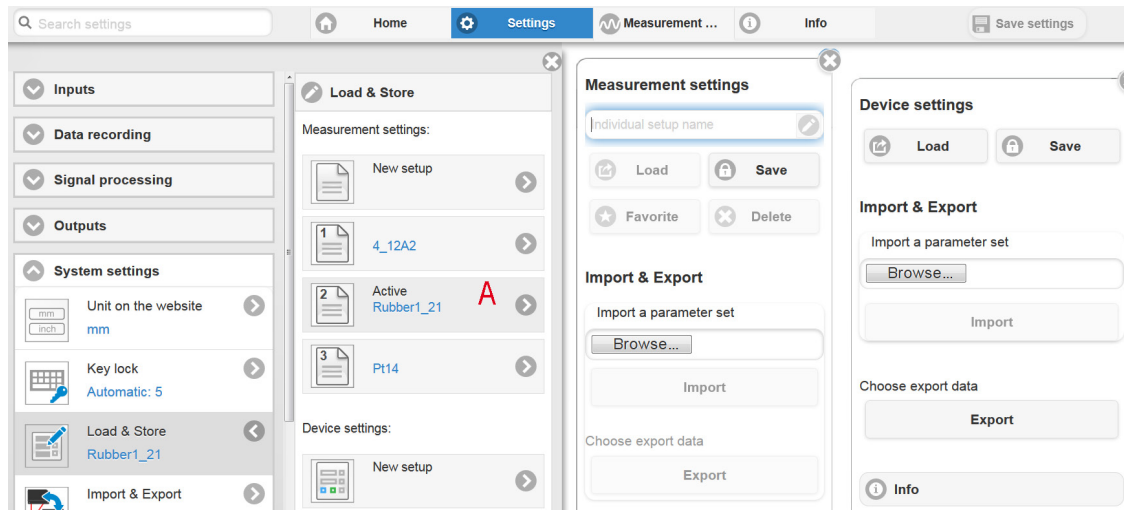

Fig. 27 Language selection in the menu bar

### 7.7.3 Load & Save

All sensor settings can be permanently saved in user programs, so-called setups, in the sensor.



For details about measurement and device settings, please refer to the section reset sensor, see Chap. 7.7.5.

Fig. 28 Managing user settings

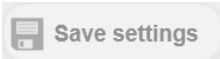
How to manage the sensor settings, options			
Saving the settings	Activating existing setup	Saving changes in active setup	Defining setup after booting
New setup menu	Load & Save menu	Menu bar	Load & Save menu
<p>➡ Enter the name for the setup into field</p> <p><input type="text" value="Individual setup name"/></p> <p>e.g. Rubber_1_21 and click the Save button.</p>	<p>➡ Click on the desired setup with the left mouse button, area A.</p> <p>The Measurement settings dialog opens.</p> <p>➡ Click the Load button.</p>	<p>➡ Click the</p> <p></p> <p>button.</p>	<p>➡ Click on the desired setup with the left mouse button, area A.</p> <p>The Measurement settings dialog opens.</p> <p>➡ Click the Favorite button.</p>

<b>How to exchange setups with PC/notebook, options</b>	
<b>Saving setup on PC</b>	<b>Loading setup from PC</b>
Load & Save menu	Load & Save menu
<p>➡ Click on the desired setup with the left mouse button, area A.</p> <p>The Measurement settings dialog opens.</p> <p>➡ Click Export.</p>	<p>➡ Left-click on New setup.</p> <p>The Measurement settings dialog opens.</p> <p>➡ Click Search.</p> <p>A Windows dialog for file selection opens.</p> <p>➡ Choose the desired file and click the Open button.</p> <p>➡ Click the Import button.</p>



### 7.7.4 Import, Export

A parameter set includes the current settings, setup(s) and the initial setup when booting the sensor. The `Import` & `Export` menu enables easy exchange of parameter sets with a PC/notebook.

How to exchange parameter sets with PC/notebook, options	
Storing parameter set on PC	Loading parameter set from PC
Import & Export menu	Import & Export menu
<p>➡ Left-click on the <code>Create a parameter set</code> button.</p> <p>The dialog <code>Choose export data</code> opens.</p> <p>➡ Compose a parameter set by checking/unchecking the checkboxes.</p> <p>➡ Click the <code>Transmit file</code> button.</p> <p>A Windows dialog for data transfer opens.</p> <p>➡ Confirm the dialog with <code>OK</code>.</p> <p>The operating system files the parameter set in <code>Download</code>. The file name for the adjacent example is <code>&lt;...\Downloads\ILD1900_BASIC-SETTINGS_MEASSETTINGS_... .JSON&gt;</code></p>	<p>➡ Click <code>Search</code>.</p> <p>A Windows dialog for file selection opens.</p> <p>➡ Choose the desired file and click on the button <code>Open</code>.</p> <p>The dialog <code>Choose import data</code> opens.</p> <p>➡ Select the operations to be performed by checking/unchecking the checkboxes.</p> <p>➡ Click the <code>Transmit file</code> button.</p>

✕

**Choose export data**

**Settings**

`4_12A2`

`Rubber1_21`

`Pt14`

**Initial Setup at booting**

`Rubber1_21`

**General Sensor settings**

`General Sensor settings`

**Transmit file**

In order to avoid that an already existing setup is overwritten unintentionally during import, an automatic security request is carried out, see adjacent figure.

#### Options during import

- `Overwrite existing setups (with the same name)`
- `Apply settings of the imported initial setup`

### 7.7.5 Reset Sensor

Reset sensor	Device settings	<i>Button</i>	<i>Clears the settings for baud rate, language, unit, key lock and echo mode and loads the default parameters.</i>
	Measurement setting	<i>Button</i>	<i>Clears the settings for measuring rate, trigger, evaluation range, peak selection, error handling, averaging, zeroing/mastering, data reduction and setups. Loads the 1st preset.</i>
	Reset all	<i>Button</i>	<i>Clears the sensor settings, measurement settings, access authorization, password and setups. Loads the 1st preset.</i>
	Reboot sensor	<i>Button</i>	<i>Reboots the sensor with the settings from the favorite setup, see Chap. <a href="#">7.7.4</a>.</i>

### 7.7.6 Bootmode

- EtherCAT: The sensor starts or switches to regular EtherCAT mode.
- Ethernet setup mode: The sensor switches to recovery mode (enables installation of firmware without EtherCAT, see Chap. [A 3](#)).

 Save your settings when you have finished programming, see Chap. [7.7.3](#).

You must exit the web interface to be able to start EtherCAT, see Chap. [8.2](#).

 Fields with gray background require a selection.

 *Value* Fields with dark border require entry of a value

## 8. EtherCAT

### 8.1 Preliminary Remarks

The sensor starts with the last stored operating mode. Standard is EtherCAT.

The Ethernet setup mode enables, just like EoE, easy programming of a sensor, see Chap. 6.2.2, see Chap. 7.

### 8.2 Saving the Settings, Continuing EtherCAT Operation

➡ Go to Settings > System settings > Load & Save or click the Save settings button, see Chap. 7.7.3.

The sensor now also saves the settings to the SD objects for use in EtherCAT operation.

➡ Go to Settings > System settings > Boot mode. Select the entry Industrial Ethernet (EtherCAT).

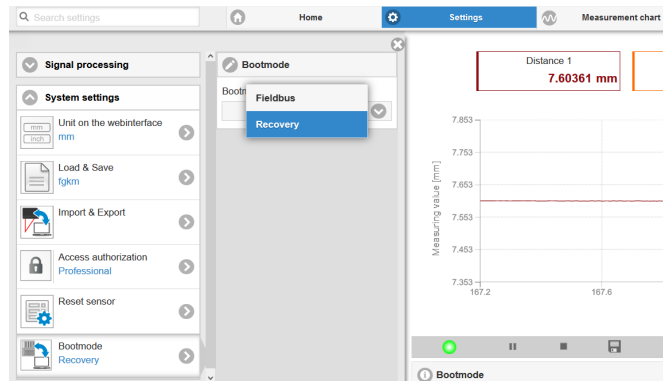

The sensor disconnects from the browser and boots automatically with the EtherCAT firmware. The boot process can take up to one minute.

Alternatively, you can return to the EtherCAT operation via the `Select` button. Details can be found in section `Switch between Ethernet Setup Mode and EtherCAT`, see Chap. A 4.

Continue working in your PLC environment.

## 9. Cleaning

We recommend cleaning the protective glass at regular intervals.

### Dry Cleaning

This can be accomplished with an anti-static lens brush or by blowing off the windows with dehumidified, clean, oil-free compressed air.

### Wet Cleaning

Use a clean, soft, lint-free cloth or lens cleaning paper and pure alcohol (isopropyl alcohol) to clean the protective glass pane.

Never use commercially available glass cleaner or other cleaning agents.

## 10. Disclaimer

All components of the device have been checked and tested for functionality in the factory. However, should any defects occur despite careful quality control, these shall be reported immediately to MICRO-EPSILON or to your distributor / retailer.

MICRO-EPSILON undertakes no liability whatsoever for damage, loss or costs caused by or related in any way to the product, in particular consequential damage, e.g., due to

- non-observance of these instructions/this manual,
- improper use or improper handling (in particular due to improper installation, commissioning, operation and maintenance) of the product,
- repairs or modifications by third parties,
- the use of force or other handling by unqualified persons.

This limitation of liability also applies to defects resulting from normal wear and tear (e.g., to wearing parts) and in the event of non-compliance with the specified maintenance intervals (if applicable).

MICRO-EPSILON is exclusively responsible for repairs. It is not permitted to make unauthorized structural and / or technical modifications or alterations to the product. In the interest of further development, MICRO-EPSILON reserves the right to modify the design.

In addition, the General Terms of Business of MICRO-EPSILON shall apply, which can be accessed under Legal details | Micro-Epsilon <https://www.micro-epsilon.com/impressum/>. For translations into other languages, the German version shall prevail.

## 11. Service, Repair

If the sensor or sensor cable is defective:

- If possible, save the current sensor settings in a parameter set, see Chap. 7.7.3, to reload them into the sensor after the repair.
- Please send us the affected parts for repair or exchange.

If the cause of a fault cannot be clearly identified, please send the entire measuring system to:

MICRO-EPSILON Optronic GmbH  
Lessingstraße 14

01465 Langebrück / Germany

Tel. +49 (0) 35201 / 729-0

Fax +49 (0) 35201 / 729-90

optronic@micro-epsilon.com

www.micro-epsilon.com

## 12. Decommissioning, Disposal

In order to avoid the release of environmentally harmful substances and to ensure the reuse of valuable raw materials, we draw your attention to the following regulations and obligations:

- Remove all cables from the sensor and/or controller.
- Dispose of the sensor and/or the controller, its components and accessories, as well as the packaging materials in compliance with the applicable country-specific waste treatment and disposal regulations of the region of use.
- You are obliged to comply with all relevant national laws and regulations

For Germany / the EU, the following (disposal) instructions apply in particular:

- Waste equipment marked with a crossed garbage can must not be disposed of with normal industrial waste (e.g. residual waste can or the yellow recycling bin) and must be disposed of separately. This avoids hazards to the environment due to incorrect disposal and ensures proper recycling of the old appliances.
- A list of national laws and contacts in the EU member states can be found at [https://ec.europa.eu/environment/topics/waste-and-recycling/waste-electrical-and-electronic-equipment-veee\\_en](https://ec.europa.eu/environment/topics/waste-and-recycling/waste-electrical-and-electronic-equipment-veee_en). Here you can inform yourself about the respective national collection and return points.
- Old devices can also be returned for disposal to MICRO-EPSILON at the address given in the imprint at <https://www.micro-epsilon.de/impressum/>.
- We would like to point out that you are responsible for deleting the measurement-specific and personal data on the old devices to be disposed of.
- Under the registration number WEEE-Reg.-Nr. DE28605721, we are registered at the foundation Elektro-Altgeräte Register, Nordostpark 72, 90411 Nuremberg, as a manufacturer of electrical and/or electronic equipment.

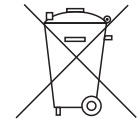

## Appendix

### A 1 Optional Accessories

PS2020	 A blue, rectangular power supply unit with a top-hat rail. The front panel features a digital display, several status LEDs, and a yellow emergency stop button. The PULS logo is visible on the front.	Power supply for top-hat rail installation, input 230 VAC, output 24 VDC/2.5 A
PC1900-IE-x/RJ45		Interfaces and supply cable Length x = 3, 6 or 9 m 12-pin round socket and RJ45 plug for fieldbus connection
PC1900-IE-x/OE-RJ45		Power and output cable, Length x = 3, 6 or 9 m 12-pin round socket, RJ45 plug for fieldbus connection or open ends for supply and laser activation

## A 2 Factory Settings

Measurement averaging	Median, 9 values	Measuring rate	4 kHz
Peak selection	Highest peak	Language	German
Measuring range	100 % FSO: digital 163768 0 % FSO: digital 98232		

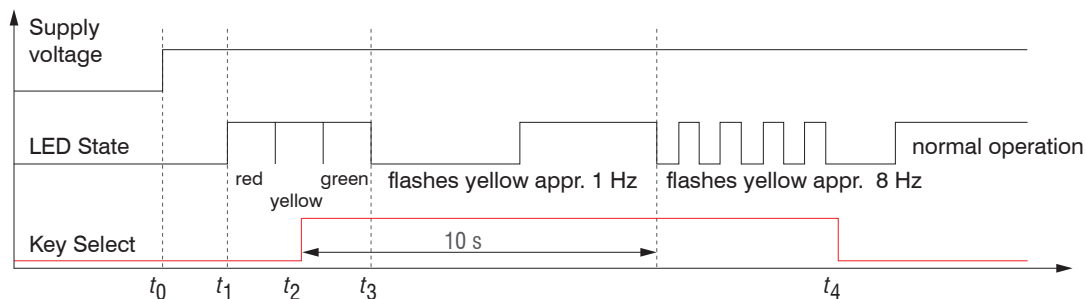

Fig. 29 Flowchart for starting a sensor with factory settings

- $t_0$ : Supply voltage is applied
- $t_1 \dots t_3$ : both LEDs indicate the start sequence (red-yellow-green each for 1 sec.)
- $t_2$ : Select button is pushed during the start sequence ( $t_1 \dots t_3$ )
- $t_4$ : Select button is released while the State LED is flashing yellow  
 $\Delta t = t_4 - t_2$ ;  $\Delta t$  (key stroke duration) must be at least 10 sec., max. 15 sec.

Reset to factory setting: Press the `Select` button after having switched on the sensor while the two LEDs light up „red - yellow - green“. Hold the key pressed. After 10 seconds, the Status LED starts flashing quickly. If you release the key while it flashes quickly, the sensor is reset to factory settings. If you hold the key pressed for longer than 15 seconds, the sensor is not reset to factory settings.

If the `Select` button is kept pressed when switching on the sensor (or with a reset), the sensor switches to the Bootloader mode.

### A 3 Switching between EtherCAT and Ethernet Setup Mode

The sensor starts in the last stored operating mode. Factory setting is EtherCAT. Access via Ethernet is possible in the Ethernet setup mode.

▶ Press and hold the Select button on the sensor before switching on the power supply on the sensor. Release the button again as soon as the State LED flashes yellow. Press the button again for approx. 10 to 15 seconds until the State LED flashes red.

Within the time  $t_2 \dots t_3$ , red flashing starts with 8 Hz after 10 seconds. The key must be released again after 15 seconds at the latest. When the Select key is released at the latest at time  $t_3$ , the State LED starts to flash yellow at 8 Hz.

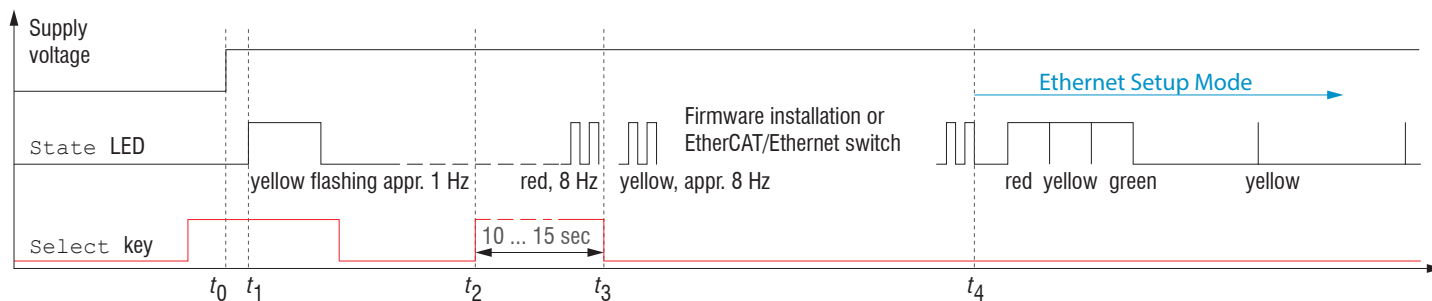

Fig. 30 Flowchart for starting a sensor in Ethernet setup mode

After completion of the firmware installation/switch, the sensor reboots at time  $t_4$ .

$t_0$ : Supply voltage is applied

$t_1$ : The State LED starts flashing yellow, the Select button can be released

$t_2$ : Within 15 sec. ( $t_2 - t_1$ ) press Select button again and hold for further 10 ... 15 sec. ( $t_3 - t_2$ )

$t_3 \dots t_4$ : Switches from EtherCAT to Ethernet setup mode, duration max. 1 min.

$t_4$ : Sensor starts in Ethernet setup mode, the State LED lights up briefly at intervals of approx. 1 sec.



## A 4 Switch between Ethernet Setup Mode and EtherCAT

The sensors start in the last stored operating mode. With the Select button, you can set the sensor to the EtherCAT operating mode.

▶ Press and hold the Select button on the sensor before switching on the power supply on the sensor. Release the button again as soon as the State LED flashes yellow. Press the button again for approx. 10 to 15 seconds until the State LED flashes red.

Within the time  $t_2 \dots t_3$ , red flashing starts with 8 Hz after 10 seconds. The key must be released again after 15 seconds at the latest. When the Select key is released at the latest at time  $t_3$ , the State LED starts to flash yellow at 8 Hz.

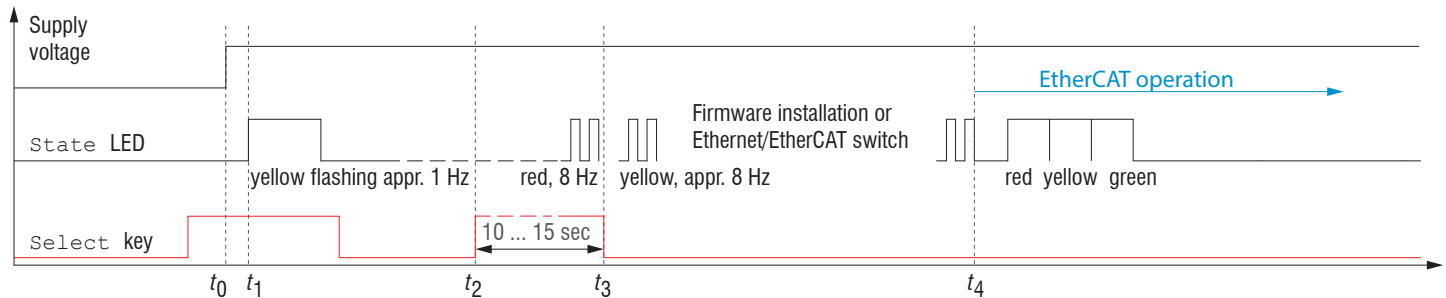

Fig. 31 Flowchart for starting a sensor in EtherCAT operation mode

After completion of the firmware installation/switch, the sensor reboots at time  $t_4$ .

- $t_0$ : Supply voltage is applied
- $t_1$ : The State LED starts flashing yellow, the Select button can be released
- $t_2$ : Within 15 sec. ( $t_2 - t_1$ ) press Select button again and hold for further 10 ... 15 sec. ( $t_3 - t_2$ )
- $t_3 \dots t_4$ : Switches from Ethernet setup mode to EtherCAT, duration max. 1 min.
- $t_4$ : Sensor starts in EtherCAT operation mode.

## **A 5 EtherCAT Documentation**

### **A 5.1 General**

EtherCAT® is, from the Ethernet viewpoint, a single, large Ethernet station that transmits and receives Ethernet telegrams. Such an EtherCAT system consists of an EtherCAT master and up to 65535 EtherCAT slaves.

Master and slaves communicate via a standard Ethernet wiring. On-the-fly processing hardware is used in each slave. The incoming Ethernet frames are directly processed by the hardware. Relevant data are extracted or added from the frame. The frame is then sent on to the next EtherCAT® slave device. The completely processed frame is sent back from the last slave device. Various protocols can be used in the application level. CANopen over EtherCAT technology (CoE) is supported here. In the CANopen protocol, an object tree with Service Data Objects (SDO) and Process Data Objects (PDO) is used to manage the data. Further information can be obtained from ® EtherCAT Technology Group ([www.ethercat.org](http://www.ethercat.org)) or Beckhoff GmbH, ([www.beckhoff.com](http://www.beckhoff.com)).

## A 5.2 Introduction

### A 5.2.1 Structure of EtherCAT® Frames

The transfer of data occurs in Ethernet frames with a special Ether type (0x88A4). Such an EtherCAT® frame consists of one or several EtherCAT® telegrams, each of which is addressed to individual slaves / storage areas. The telegrams are either transmitted directly in the data area of the Ethernet frame or in the data area of the UDP datagram. An EtherCAT® telegram consists of an EtherCAT® header, the data area and the work counter (WC). The work counter is incremented by each addressed EtherCAT® slave that exchanged the corresponding data.

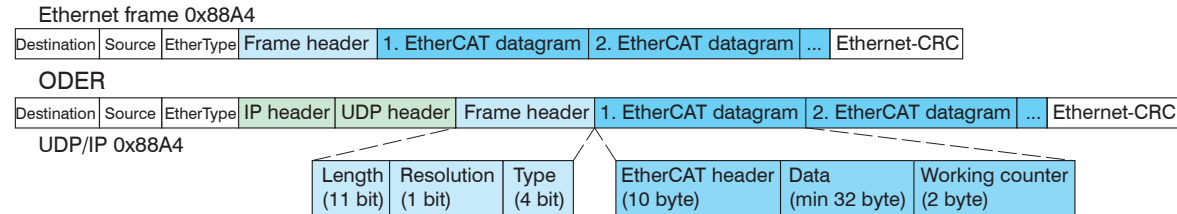

Fig. 32 Setup of EtherCAT frames

### A 5.2.2 EtherCAT® Services

EtherCAT® services specify the reading and writing of data in the physical memory of the slave hardware. The following EtherCAT® services are supported by the slave hardware:

- APRD (Auto-Increment Physical Read, reading of a physical area with auto-increment addressing)
- APWR (Auto-Increment Physical Write, writing of a physical area with auto-increment addressing)
- APRW (Auto-Increment Physical Read Write, reading and writing of a physical area with auto-increment addressing)
- FPRD (Configured Address Read, reading of a physical area with fixed addressing)
- FPWR (Configured Address Write, writing of a physical area with fixed addressing)
- FPRW (Configured Address Read Write, reading and writing of a physical area with fixed addressing)
- BRD (Broadcast Read, broadcast-reading of a physical area for all slaves)
- BWR (Broadcast Write, broadcast-writing of a physical area for all slaves)
- LRD (Logical Read, reading of a logical storage area)
- LWR (Logical Write, writing of a logical storage area)
- LRW (Logical Read Write, reading and writing of a logical storage area)
- ARMW (Auto-Increment Physical Read Multiple Write, reading of a physical area with auto-increment addressing, multiple writing)

- FRMW (Configured Address Read Multiple Write, reading of a physical area with fixed addressing, multiple writing)

### A 5.2.3 Addressing and FMMUs

In order to address a slave in the EtherCAT® system, various methods from the master can be used. The sensor supports Full-Slave:

- Position addressing  
The slave device is addressed via its physical position in the EtherCAT® segment.  
The services used for this are APRD, APWR, APRW.
- Node addressing  
The slave device is addressed via a configured node address, which was assigned by the master during the commissioning phase.  
The services used for this are FPRD, FPWR and FPRW.
- Logical addressing  
The slaves are not addressed individually; instead, a segment of the segment-wide logical 4-GB address is addressed. This segment can be used by a number of slaves.  
The services used for this are LRD, LWR and LRW.

The local assignment of physical slave memory addresses and logical segment-wide addresses is implemented via the field bus Memory Management Units (FMMUs). The configuration of the slave FMMUs is implemented by the master. The FMMU configuration contains a start address of the physical memory in the slave, a logical start address in the global address space, length and type of the data, as well as the direction (input or output) of the process data.

### A 5.2.4 Sync Manager

Sync Managers serve the data consistency during the data exchange between EtherCAT® master and slaves. Each Sync Manager channel defines an area of the application memory. The sensor has four channels.

- Sync manager channel 0: Sync manager 0 is used for mailbox write transfers (mailbox from master to slave).
- Sync manager channel 1: Sync manager 1 is used for mailbox read transfers (mailbox from slave to master).
- Sync manager channel 2: Sync manager 2 is normally used for process output data. Not used in the sensor.
- Sync manager channel 3: Sync manager 3 is used for process input data. It contains the Tx PDOs that are specified by the PDO assignment object 0x1C13 (hex.).

### A 5.2.5 EtherCAT State Machine

The EtherCAT® state machine is implemented in each EtherCAT®. Immediately after switching on the sensor, the state machine is in the "Initialization" state. In this state, the master has access to the DLL information register of the slave hardware. The mailbox is not yet initialized, i.e. communication with the application (sensor software) is not yet possible. During the transition to the pre-operational state, the Sync Manager channels are configured for the mailbox communication. In the „Pre-Operational“ state, communication via the mailbox is possible, and it can access the object directory and its objects. In this state, no process data communication occurs. During the transition to the „Safe-Operational“ state, the process-data mapping, the Sync Manager channel of the process inputs and the corresponding FMMU are configured by the master. Mailbox communication continues to be possible in the „Safe-Operational“ state. The process data communication runs for the inputs. The outputs are in the „safe“ state. In the „Operational“ state, process data communication runs for the inputs as well as the outputs.

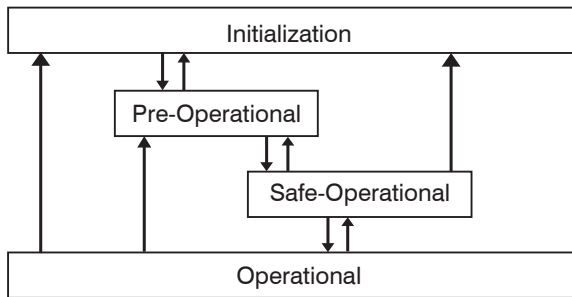

Fig. 33 EtherCAT State Machine

### A 5.2.6 CANopen over EtherCAT

The application level communication protocol in EtherCAT is based on the communication profile CANopen DS 301 and is designated either as "CANopen over EtherCAT" or CoE. The protocol specifies the object directory in the sensor, as well as the communication objects for the exchange of process data and acyclic messages. The sensor uses the following message types:

- Process Data Object (PDO). The PDO is used for the cyclic I/O communication, i.e. for process data.
- Service Data Object (SDO). The SDO is used for acyclic data transmission.

The object directory is described in the chapter CoE Object Directory.

### A 5.2.7 Process Data PDO Mapping

Process Data Objects (PDOs) are used for the exchange of time-critical process data between master and slaves. Tx PDOs are used to transfer data from the slave to the master (inputs). Rx PDOs are used to transfer data from the master to the slave (outputs); this concept is not used in sensor. The PDO mapping defines which application objects (measurement data) are transmitted into a PDO. You can choose from a series of Tx PDO mapping objects.

In EtherCAT the PDOs are transported in objects of the Sync Manager channel. The sensor uses the Sync Manager channel SM3 for input data (Tx data). The PDO assignments of the Sync Manager can only be changed in the “Pre-Operational” state.

**Note:** Subindex 0h of the object 0x1A00 contains the number of valid entries within the mapping report. This number also represents the number of application variables (parameters) that should be transmitted/received with the corresponding PDO. The subindices from 1h up to the number of objects contain information about the depicted application variables. The mapping values in the CANopen objects are coded in hexadecimal form.

The following table contains an example of the entry structure of the PDO mapping:

MSB		LSB	
31	16 15	8 7	0
Index e.g. 0x6000 (16 bit)	Subindex e.g. 0x01	Object length in bits, e.g. 20h = 32 bits	

Fig. 34 Entry structure of the PDO mapping, example

### A 5.2.8 Service Data SDO Service

Service Data Objects (SDOs) are primarily used for the transmission of data that are not time critical, e.g. parameter values.

EtherCAT specifications

- SDO services make possible the read/write access to entries in the CoE object directory of the device.
- SDO information services make it possible to read the object directory itself and to access the properties of the objects.

All parameters of the measuring device can be read or changed in this way, and measurements can be transmitted. A desired parameter is addressed via index and subindex within the object directory.

### A 5.3 CoE – Object Directory

The CoE object directory (CANopen over EtherCAT) contains all the configuration data of the sensor. The objects in CoE object directory can be accessed using the SDO services. Each object is addressed using a 16-bit index. With each build, the `object_documentation.csv` file is generated for the sensor, in which all objects are listed.

#### A 5.3.1 Communication-Specific Standard Objects

##### A 5.3.1.1 Overview

Index (h)	Name	Description
1000	Device type	Device type
1008	Device name	Manufacturer device name
1009	Hardware version	Hardware version
100A	Software version	Software version
1018	Identity	Device identification
10F8	Timestamp	EtherCAT stack predefined object, not to be confused with the timestamp of the process data.
1A00 ... 1A16		TxPDO Mapping PDO mapping objects may contain merged process data (mappable objects - process data).
1C00	Sync. manager type	Synch. manager type
1C12	RxPDO assign	
1C13	TxPDO assign	TxPDO assign
1C32	Sync manager output parameter	Synchronous mode parameter (DC)
1C33	Sync manager input parameter	

Fig. 35 Standard objects - Overview

**A 5.3.1.2 Object 1000h: Device Type**

1000	VAR	Device type	0x00000000	Unsigned32	ro
------	-----	-------------	------------	------------	----

Provides information about the used device profile and the device type.

**A 5.3.1.3 Object 1008h: Manufacturer Device Name**

1008	VAR	Device name	ILD1900	Visible String	ro
------	-----	-------------	---------	----------------	----

**A 5.3.1.4 Object 1009h: Hardware Version**

1009	VAR	Hardware version	xx	Visible String	ro
------	-----	------------------	----	----------------	----

**A 5.3.1.5 Object 100Ah: Software Version**

100A	VAR	Software version	xxx.xxx	Visible String	ro
------	-----	------------------	---------	----------------	----

**A 5.3.1.6 Object 1018h: Device Identification**

1018	RECORD	Identity			
------	--------	----------	--	--	--

Subindices

0	VAR	Number of entries	4	Unsigned8	ro
1	VAR	Vendor ID	0x00000607	Unsigned32	ro
2	VAR	Product code	0x60CB01F6	Unsigned32	ro
3	VAR	Revision	0x00010000	Unsigned32	ro
4	VAR	Serial number	0x13223A25	Unsigned32	ro

The product code identifies an EtherCAT device in the network. This identification is composed of vendor ID, product code and revision. The Serial number contains the the sensors serial number.



**A 5.3.1.7 TxPDO Mapping**

0x1A00	Frequency + exposure time TxPDOMap OV1			
	0x6000:001 out_shutter + 0x6001:001 out_frequency			
0x1A01	Frequency + exposure time TxPDOMap OV2			
	0x6000:001 out_shutter + 0x6001:001 out_frequency	0x6000:002 out_shutter + 0x6001:002 out_frequency		
0x1A02	Frequency + exposure time TxPDOMap OV4			
	0x6000:001 out_shutter + 0x6001:001 out_frequency	0x6000:002 out_shutter + 0x6001:002 out_frequency	0x6000:003 out_shutter + 0x6001:003 out_frequency	0x6000:004 out_shutter + 0x6001:004 out_frequency
0x1A03	Reserved			
0x1A04	Timestamp TxPDOMap OV1			
	0x6002:001 out_frametimestamp			
0x1A05	Timestamp TxPDOMap OV2			
	0x6002:001 out_frametimestamp	0x6002:002 out_frametimestamp		
0x1A06	Timestamp TxPDOMap OV4			
	0x6002:001 out_frametimestamp	0x6002:002 out_frametimestamp	0x6002:003 out_frametimestamp	0x6002:004 out_frametimestamp
0x1A07	Reserved			

0x1A08	Measured Value Counter OV1			
	0x6003:001 out_counter			
0x1A09	Measured Value Counter OV2			
	0x6003:001 out_counter	0x6003:002 out_counter		
0x1A0A	Measured Value Counter OV4			
	0x6003:001 out_counter	0x6003:002 out_counter	0x6003:003 out_counter	0x6003:004 out_counter
0x1A0B	Reserved			
0x1A0C	Status OV1			
	0x6004:001 out_status			
0x1A0D	Status OV2			
	0x6004:001 out_status	0x6004:002 out_status		
0x1A0E	Status OV4			
	0x6004:001 out_status	0x6004:002 out_status	0x6004:003 out_status	0x6004:004 out_status
0x1A0F	Reserved			

0x1A10	Not linearized distance + intensity + distance OV1			
	0x6005:001 out_unlin + 0x6006:001 out_intensity + 0x6007:001 out_lin			
0x1A11	Not linearized distance + intensity + distance OV2			
	0x6005:001 out_unlin + 0x6006:001 out_intensity + 0x6007:001 out_lin	0x6005:002 out_unlin + 0x6006:002 out_intensity + 0x6007:002 out_lin		
0x1A12	Not linearized distance + intensity + distance OV4			
	0x6005:001 out_unlin + 0x6006:001 out_intensity + 0x6007:001 out_lin	0x6005:002 out_unlin + 0x6006:002 out_intensity + 0x6007:002 out_lin	0x6005:003 out_unlin + 0x6006:003 out_intensity + 0x6007:003 out_lin	0x6005:004 out_unlin + 0x6006:004 out_intensity + 0x6007:004 out_lin
0x1A13	Reserved			
0x1A14	Peak distance OV1			
	0x6008:001 out_01_peak1_distance			
0x1A15	Peak distance OV2			
	0x6008:001 out_01_peak1_distance	0x6008:002 out_01_peak1_distance		
0x1A16	Peak distance OV4			
	0x6008:001 out_01_peak1_distance	0x6008:002 out_01_peak1_distance	0x6008:003 out_01_peak1_distance	0x6008:004 out_01_peak1_distance
0x1A17	Reserviert			

Fig. 36 PDO mapping objects

Only PDO mappings that have the same oversampling may be selected. If the sensor was integrated via an ESI file, PDO mappings are already mutually exclusive when being selected, depending on the PLC software. If this is not the case because the PLC development software does not support this feature or the sensor has been integrated online without an ESI file, an invalid combination of PDO mappings will result in an error message and the process data will not be transferred to the EtherCAT master.

In object 0x1C13 is selected which PDOs are transferred. The PDO mapping objects are selected. The selection process takes place before switching from PreOP to SafeOP mode.

**Example 1:** Startup procedure to output distance 1 (01DIST1):

- Distance 1 is output in 0x6007. In order to transfer 0x6007 in the PDO, the PDO mapping object 0x1A10 must be selected in 0x1C13.

1C13:0	TxPDO assign	RW	> 1 <
1C13:01	SubIndex 001	RW	0x1A10 (6672)
1C13:02	SubIndex 002	RW	---
1C13:03	SubIndex 003	RW	---
1C13:04	SubIndex 004	RW	---
1C13:05	SubIndex 005	RW	---
1C13:06	SubIndex 006	RW	---

0x1A10 is now mapped, the following PDOs will be transmitted:

1A10:0	Unlin + Intensity + Lin TxPDO Map OV1	RO	> 3 <
1A10:01	SubIndex 001	RO	0x6005:01. 32
1A10:02	SubIndex 002	RO	0x6006:01. 32
1A10:03	SubIndex 003	RO	0x6007:01. 32

As PDOs are grouped, 0x6007:01 contains the linearized distance value; 0x6005:01 still contains the unlinearized value and 0x6006:01 contains the intensity.

**Example 2:** Startup procedure to output distance 1, intensity and the timestamp.

1C13:0	TxPDO assign	RW	> 2 <
1C13:01	SubIndex 001	RW	0x1A04 (6660)
1C13:02	SubIndex 002	RW	0x1A10 (6672)
1C13:03	SubIndex 003	RW	---
1C13:04	SubIndex 004	RW	---
1C13:05	SubIndex 005	RW	---
1C13:06	SubIndex 006	RW	---

0x1A04 and 0x1A10 are now mapped, the following PDOs will be transmitted:

1A04:0	Frame time stamp TxPDO Map OV1	RO	> 1 <
1A04:01	SubIndex 001	RO	0x6005:01. 32
1A10:0	Unlin + Intensity + Lin TxPDO Map OV1	RO	> 3 <
1A10:01	SubIndex 001	RO	0x6005:01. 32
1A10:02	SubIndex 002	RO	0x6006:01. 32
1A10:03	SubIndex 003	RO	0x6007:01. 32

As PDOs are grouped, 0x6002:01 contains the timestamp; 0x6006:01 contains the intensity and 0x6007:01 contains the distance value. 0x6005:01 still contains the unlinearized value.

**A 5.3.1.8 Object 1C00h: Synchronous Manager Type**

1C00	RECORD	Sync manager type			ro
------	--------	-------------------	--	--	----

## Subindices

0	VAR	Number of entries	4	Unsigned8	ro
1	VAR	Sync manager 1	0x01	Unsigned8	ro
2	VAR	Sync manager 2	0x02	Unsigned8	ro
3	VAR	Sync manager 3	0x03	Unsigned8	ro
4	VAR	Sync manager 4	0x04	Unsigned8	ro

For more details, please refer to the section Data Exchange between EtherCAT® Master and Slave, see Chap. [A 5.2.4](#).

**A 5.3.1.9 Object 1C12h: RxPDO Assign**

1C12	ARRAY	RxPDO Assign			rw
------	-------	--------------	--	--	----

## Subindices

0	VAR	Number of entries	0	Unsigned8	ro
---	-----	-------------------	---	-----------	----

No RxPDOs can be selected because none are present. The object is implemented as a dummy to enable the EtherCAT master to set the RxPDOs to 0.

**A 5.3.1.10 Object 1C13h: TxPDO Assign**

1C13	ARRAY	TxPDO Assign			rw
------	-------	--------------	--	--	----

## Subindices

0	VAR	Number of entries	n	Unsigned8	rw
1	VAR	Subindex 001	0x1A00	Unsigned16	rw
2	VAR	Subindex 002	0x1A04	Unsigned16	rw
..					
6	VAR	Subindex 006	0x1A14	Unsigned16	rw

Object for selecting the PDOs (TxPDO maps).

**A 5.3.1.11 Object 1C32h: Synchronization Manager Input Parameters**

see description of input parameters, see Chap. A 5.3.1.12.

**A 5.3.1.12 Object 1C33h: Synchronization Manager Input Parameters**

1C33	RECORD	SM input parameter			ro
------	--------	--------------------	--	--	----

## Subindices

0	VAR	Number of entries	9	Unsigned8	ro
1	VAR	Synchronization type	x	Unsigned16	ro
2	VAR	Cycle time	x	Unsigned32	ro
4	VAR	Supported synchronization types	0x4007	Unsigned16	ro
5	VAR	Minimum cycle time	100000	Unsigned32	ro
6	VAR	Calc and copy time	x	Unsigned32	ro
8	VAR	Get cycle time	x	Unsigned16	ro
9	VAR	Delay time	x	Unsigned32	ro
0C	VAR	Cycle time too small counter	x	Unsigned16	ro
20	VAR	Sync error	x	Bit	ro

- Synchronization Type: currently specified synchronization, see [Fig. 37](#).
- Cycle Time: currently specified cycle time in ns
  - Free run: the cycle time derived from the measuring rate,
  - SM2, SM3: the cycle time derived from the measuring rate,
  - Sync0 synchronization, the Sync0 cycle time set by the master.
- Supported synchronization types:
  - Freerun, SM2 / SM3 and Sync0 synchronization
- Minimum cycle time: the minimum cycle time is derived from the maximum measuring rate and is 100  $\mu$ s.
- Calc and Copy Time: The Calc and Copy time is the time after the input latch (input data are available in the slave) until the input data is copied into the Sync-Manager-3 area (transfer of the data to Industrial Ethernet). The Calc and Copy Time from 0x1C33 is only calculated if the Distributed Clocks are enabled. The value is recalculated each time it is read. Since the sensor does not have output data, the Calc and copy time of 0x1C32 always returns 0.

- Delay time: The delay time is the hardware-related delay until the input latch is reached.
- The delay time from 0x1C33 is only calculated if the Distributed Clocks are activated. The value is recalculated each time it is read. Since the sensor does not have output data, the Delay time from 0x1C32 always returns 0.
- Cycle Time Too Small Counter: This counter is incremented if the cycle time is too low, so that the input data could not be provided for the next SM event.
- Sync Error
  - 0: No errors.
  - 1: An synchronization error occurred. The Cycle Time Too Small Counter has been incremented.

The set synchronization depends on the combination of 0x1C33:001 and 0x1C32:001. The synchronization changes during a transition from the PreOP state to the SafeOP state. If the combination is invalid, an error message is displayed when the state is changed. Process data communication will then not be possible.

0x1C32 Synchronization Type	0x1C33 Synchronization Type	Synchronization
0x00	0x00	Free run
0x01	0x22	SM2
0xyy	0x01	SM3
0x02	0x02	Sync0

*Fig. 37 Example synchronisation*

An activation of the Distributed Clocks does not automatically change the Sync0 mode. The synchronization can only be changed by writing the objects 0x1C32 and 0x1C33.



### A 5.3.2 Manufacturer Specific Objects

#### Overview

Index (h)	Name	Description
3000	Laser power	Laser light source
3200	Data recording	Measuring program such as measuring rate and peak selection
3400	Signal processing peak 1	Measurement averaging
3450	Mastering	Zeroing and Mastering
3800	System settings	Systems settings such as login and factory settings
3850	Device settings	Definition of measurement task
3851	Preset settings	Definition of signal quality
3852	Measurement settings	Load, save
3900	Sensor information	Information on measuring range and option of sensor
6000	Out_shutter	Output value exposure time
6001	Out_frequency	Output value measuring rate
6002	Out_frametimestamp	Output value timestamp
6003	Out_framecounter	Output value measurement counter
6004	Out_framestatus	Output value frame status
6005	Out_01_md_unlin	Output value not linearized distance value
6006	Out_md_intensity	Output value intensity
6007	Out_01_md_lin	Output value linearized distance value
6008	Out_01_peak1_distance	Output value peak distance

The following is a description of the individual objects with their sub-indices. A description of the functionality of the sensor parameters can be found in the corresponding sections of the operating instructions for the sensor.

**A 5.3.2.1 Object 3000h: Light Source**

3000	RECORD	Laser power
------	--------	-------------

## Subindices

0	VAR	Number of entries	1	UINT8	ro
1	VAR	Laser power	x	UINT8	rw

For more information, please refer to the Inputs section, see Chap. 7.3.

Laser power:

0 - Off,

1 - Full,

2 - Reduced

### A 5.3.2.2 Object 3200: Measurement Configuration, Measuring Rate, Evaluation Range, Exposure, Peak Selection, Error Handling

3200	RECORD	Data recording
------	--------	----------------

#### Subindices

0	VAR	Number of entries	1	UINT8	ro
1	VAR	Measurement task	x	UINT8	rw
3	VAR	Measuring rate	x	FLOAT	rw
0A	VAR	Start of range	x	UINT16	rw
0B	VAR	End of range	x	UINT16	rw
14	VAR	Shutter mode	x	UINT8	rw
15	VAR	Shutter time in us	x	FLOAT	rw
16	VAR	Exposure mode	x	UINT8	rw
1E	VAR	Peak selection	x	UINT8	rw
28	VAR	Error handling type	x	UINT8	rw
29	VAR	Error handling values	x	UINT32	rw

Measurement task:	Shutter mode:	Exposure mode:	Peak selection	Error handling type
0 - Standard	0 - Manual	0 - Standard	0 - Highest peak	0 - None
1 - Multisurface	1 - Automatic	1 - Intelligent	1 - Widest peak	1 - Value
2 - Penetration		2 - Background	2 - Last peak	2 - Infinite
			3 - First peak	

**A 5.3.2.3 Object 3400: Averaging**

3400	RECORD	Signal processing peak 1			
Subindices					
0	VAR	Number of entries	8	UINT8	ro
1	VAR	Average 1 type	x	UINT8	rw
2	VAR	Average 1 number of values for moving average	x	UINT32	rw
3	VAR	Average 1 number of values for median	x	UINT32	rw
4	VAR	Average 1 number of values for recursive	x	UINT32	rw
0B	VAR	Average 2 type	x	UINT8	rw
0C	VAR	Average 2 number of values for moving average	x	UINT32	rw
0D	VAR	Average 2 number of values for median	x	UINT32	rw
0E	VAR	Average 2 number of values for recursive	x	UINT32	rw

Average 1 type:	Average 1/2 number of values for moving average:	Average 1/2 number of values for median:	Average 1/2 number of values for recursive:	Average 2 type:
0 - None	2 - 2	3 - 3	1 - 1	0 - None
1 - Median	4 - 4	5 - 5	2 - 2	1 - Median
2 - Moving	8 - 8	7 - 7	2 - 2	2 - Moving
3 - Recursive	...	9 - 9	...	3 - Recursive
	4096 - 4096		32000 - 32000	

**A 5.3.2.4 Object 3450: Zeroing, Mastering**

3450	RECORD	Mastering			
------	--------	-----------	--	--	--

## Subindices

0	VAR	Number of entries		UINT8	ro
4	VAR	Set/Reset	x	BIT	rw
5	VAR	Value	x	FLOAT	rw

Set/Reset

0 - Reset

1 - Set

**A 5.3.2.5 Object 3800: System Settings, Key Lock, Login, Password, Factory Settings**

3800	RECORD	System settings			
Subindices					
0	VAR	Number of entries	13	UINT8	ro
1	VAR	Key lock	x	UINT8	rw
2	VAR	Key lock countdown [min]	x	UINT8	rw
0B	VAR	Current access authorization	x	UINT8	ro
0C	VAR	Login	x	STRING(32)	wo
0D	VAR	Logout	x	BIT	rw
0E	VAR	User level when restarting	x	UINT8	rw
0F	VAR	Change password old	x	STRING(32)	wo
10	VAR	Change password new	x	STRING(32)	wo
11	VAR	Change password repeat	x	STRING(32)	wo
15	VAR	Reset to factory measurement settings	x	BIT	wo
16	VAR	Reset to factory device settings	x	BIT	wo
18	VAR	Reset to factory all settings	x	BIT	wo
19	VAR	Reboot sensor	x	BIT	wo

Current access authorization	Logout	User level when restarting	Reset to factory measurement settings	Reset to factory device settings	Reset to factory all settings	Reboot sensor
1 - User	0 - No	1 - User	0 - False	0 - False	0 - False	0 - False
3 - Professional	1 - Yes	2 - Professional	1 - True	1 - True	1 - True	1 - True
4 - Professional+						

**A 5.3.2.6 Object 3850: Measurement Task**

3850	RECORD	Device settings			
------	--------	-----------------	--	--	--

## Subindices

0	VAR	Number of entries	2	UINT8	ro
1	VAR	Load	x	BIT	wo
2	VAR	Save	x	BIT	wo

Load	Save
0 - False	0 - False
1 - True	1 - True

**A 5.3.2.7 Object 3851: Signal Quality**

3851	RECORD	Presets			
------	--------	---------	--	--	--

## Subindices

0	VAR	Number of entries	3	UINT8	ro
1	VAR	Mode	x	UINT8	rw
2	VAR	List	x	STRING(230)	ro
3	VAR	Read	x	STRING(32)	wo

Mode

- 0 - None
- 1 - Static
- 2 - Balanced
- 3 - Dynamic
- 4 - No averaging

**A 5.3.2.8 Object 3852: Load, Save**

3852	RECORD	Measurement settings
------	--------	----------------------

## Subindices

0	VAR	Number of entries	6	UINT8	ro
1	VAR	Current	x	STRING(32)	ro
2	VAR	Read	x	STRING(32)	wo
3	VAR	Store	x	STRING(32)	wo
4	VAR	Delete	x	STRING(32)	wo
5	VAR	Initial	x	STRING(32)	rw
6	VAR	List	x	STRING(230)	ro

- Current: Contains the currently used user program (setup) in the `String` field.
- Read: Read loads a measuring program and activates it, enter the setup name in the `String` field and confirm with `OK`.
- Store: Store saves a measuring program, enter the setup name in the `String` field and confirm with `OK`.
- Delete: Enter setup name in the `String` field and confirm with `OK`
- Initial: Displays the user program to be loaded when the sensor is started.
- List: Displays the names of the user programs (setups).

**A 5.3.2.9 Object 3900: Sensor Information**

3900	RECORD	Sensor information
------	--------	--------------------

## Subindices

0	VAR	Number of entries	2	UINT8	ro
1	VAR	Measuring range	x	FLOAT	ro
2	VAR	Option	x	STRING32	ro

- Measuring range: measuring range of the sensor
- Option: contains the option number of the sensor



## A 5.4 Mappable Objects - Process Data

### A 5.4.1 General

Displays all individually available process data.

The objects 0x600x up to 0x6008 are structured as follows:

[INDEX]		[NAME]		
	0	Subindex 0	Uint8	ro
	1	Subindex 1	[DATA TYPE]	ro

A process data object is an array whose length corresponds to the maximum oversampling. The ILD1900-IE currently supports a maximum oversampling of 4. The object 0x6000 (frequency) therefore has the sub-indices 1, 2, 3 and 4, each representing an oversampling value.

The values of the process data can also be read asynchronously via SDOs. However, please note that only the value in sub-index 1 can be read. Older values caused by oversampling cannot be read acyclically. Accordingly, the sub-indices greater than 1 always return 0.

### A 5.4.2 Object 6000: Exposure time

Index	Name	Data type	Access
0x6000	out_shutter	ARRAY	

Subindices

0	Number of entries	Unsigned8	ro
1	out_shutter__OV00	Unsigned32	ro
2	out_shutter__OV01	Unsigned32	ro
3	out_shutter__OV02	Unsigned32	ro
4	out_shutter__OV03	Unsigned32	ro

**A 5.4.3 Object 6001: Measuring Rate**

Index	Name	Data type	Access
0x6001	out_frequency	ARRAY	

## Subindices

0	Number of entries	Unsigned8	ro
1	out_frequency_OV00	Unsigned32	ro
2	out_frequency_OV01	Unsigned32	ro
3	out_frequency_OV02	Unsigned32	ro
4	out_frequency_OV03	Unsigned32	ro

**A 5.4.4 Object 6002: Timestamp**

Index	Name	Data type	Access
0x6002	out_frametimestamp	ARRAY	

## Subindices

0	Number of entries	Unsigned8	ro
1	out_frametimestamp_OV00	Unsigned32	ro
2	out_frametimestamp_OV01	Unsigned32	ro
3	out_frametimestamp_OV02	Unsigned32	ro
4	out_frametimestamp_OV03	Unsigned32	ro

**A 5.4.5 Object 6003: Measurement counter**

Index	Name	Data type	Access
0x6003	out_framecounter	ARRAY	

## Subindices

0	Number of entries	Unsigned8	ro
1	out_framecounter_OV00	Unsigned32	ro
2	out_framecounter_OV01	Unsigned32	ro
3	out_framecounter_OV02	Unsigned32	ro
4	out_framecounter_OV03	Unsigned32	ro

**A 5.4.6 Object 6004: Frame status**

Index	Name	Data type	Access
0x6004	out_framestatus	ARRAY	

## Subindices

0	Number of entries	Unsigned8	ro
1	out_framestatus__OV00	Unsigned32	ro
...			
4	out_framestatus__OV03	Unsigned32	ro

**A 5.4.7 Object 6005: Distance value, not linearized**

Index	Name	Data type	Access
0x6005	out_01_md_unlin	ARRAY	

## Subindices

0	Number of entries	Unsigned8	ro
1	out_01_md_unlin__OV00	Unsigned32	ro
...			
4	out_01_md_unlin__OV03	Unsigned32	ro

**A 5.4.8 Object 6006: Intensity**

Index	Name	Data type	Access
0x6006	out_md_intensity	ARRAY	

## Subindices

0	Number of entries	Unsigned8	ro
1	out_md_intensity__OV00	Unsigned32	ro
...			
4	out_md_intensity__OV03	Unsigned32	ro

**A 5.4.9 Object 6007: Distance value, linearized**

Index	Name	Data type	Access
0x6007	out_01_md_lin	ARRAY	

## Subindices

0	Number of entries	Unsigned8	ro
1	out_01_md_lin__OV00	Unsigned32	ro
...			
4	out_01_md_lin__OV03	Unsigned32	ro

**A 5.4.10 Object 6008: Peak distance**

Index	Name	Data type	Access
0x6008	out_01_peak1_distance	ARRAY	

## Subindices

0	Number of entries	Unsigned8	ro
1	out_01_peak1_distance__OV00	Unsigned32	ro
...			
4	out_01_peak1_distance__OV03	Unsigned32	ro

## A 5.5 Error Codes for SDO Services

In case of a negative evaluation of an SDO requirement, a corresponding error code is output in "Abort SDO Transfer Protocol".

Error code hex	Meaning
0503 0000	Toggle-Bit has not changed
0504 0000	SDO protocol timeout expired
0504 0001	Invalid command registered
0504 0005	Not enough memory
0601 0000	Access to object (parameter) not supported
0601 0001	Attempt to write to a "read-only parameter"
0601 0002	Attempt to write to a "read-only parameter"
0602 0000	Object (parameter) is not listed in the object directory
0604 0041	Object (parameter) is not mapped on PDO
0604 0042	Number or length of objects to be transmitted exceeds PDO length.
0604 0047	General internal device incompatibility
0606 0000	Excess denied because of a hardware error
0607 0010	False data type or length of service parameter is incorrect
0607 0012	False data type or length of service parameter is too large.
0607 0013	False data type or length of service parameter is too small.
0609 0011	Sub-index does not exist
0609 0030	Invalid value of parameter (only for write access)
0609 0031	Value of the parameter too large
0609 0032	Value of the parameter too small
0609 0036	Maximum value falls below minimum value
0800 0000	General error
0800 0020	Data can not be transmitted or saved in application

0800 0021	Data can not be transmitted or saved in application due to local control unit
0800 0022	Data can not be transmitted or saved in application due to device status
0800 0023	Dynamic generation of object directory failed or no object directory is available

## A 5.6 Oversampling

In operation without oversampling, the last accumulated measured value data set is transferred to the EtherCAT master with each fieldbus cycle. Therefore, for long fieldbus cycle periods data records with measured values are possibly not available. Configurable oversampling ensures that all (or selected) measured value data records are gathered and transmitted together to the master during the next fieldbus cycle. In general, a possible oversampling depends on the ratio of sensor measuring rate to fieldbus cycle time.

The oversampling factor specifies how many samples per bus cycle are transmitted. Currently the ILD1900-IE supports oversampling of 1, 2 and 4. For example, an oversampling factor of 2 means that 2 samples are transferred per bus cycle.

With TxPDO Mapping, see Fig. 36, the base index of the PDO mapping objects is included with the oversampling factor 1. Use the following list to determine the index for selecting a different oversampling factor:

- Base index + 1: Oversampling factor 2
- Base index + 2: Oversampling factor 4
- Base index + 3: Oversampling factor 8

You can only select mapping objects with the same oversampling factor in 0x1C13h.

### Example:

- The fieldbus/EtherCAT master operates at a cycle time of 1 ms because the higher-level PLC works with a cycle time of 1 ms. This means that every 1 ms, an EtherCAT frame is sent to the ILD1900-IE to retrieve the process data. If the measurement frequency in the sensor is set to 4 kHz, an oversampling factor of 4 must be set.
- Startup procedure to output the distance value with an oversampling factor of 4.
  - The distance value is output in object 0x6007h. In order to transfer this object in the PDO, the PDO mapping object 0x1A10 must be selected in object 0x1C13:01h. However, 0x1A12 (base index 0x1A10 + 2) must be selected for the 4-fold oversampling.

1A11:0	Unlin + Intensity + Lin TxPDOMap OV2	RO	> 6 <
1A11:01	SubIndex 001	RO	0x6005:01, 32
1A11:02	SubIndex 002	RO	0x6005:02, 32
1A11:03	SubIndex 003	RO	0x6006:01, 32
1A11:04	SubIndex 004	RO	0x6006:02, 32
1A11:05	SubIndex 005	RO	0x6007:01, 32
1A11:06	SubIndex 006	RO	0x6007:02, 32
1A12:0	Unlin + Intensity + Lin TxPDOMap OV4	RO	> 12 <
1A12:01	SubIndex 001	RO	0x6005:01, 32
1A12:02	SubIndex 002	RO	0x6005:02, 32
1A12:03	SubIndex 003	RO	0x6005:03, 32
1A12:04	SubIndex 004	RO	0x6005:04, 32
1A12:05	SubIndex 005	RO	0x6006:01, 32
1A12:06	SubIndex 006	RO	0x6006:02, 32
1A12:07	SubIndex 007	RO	0x6006:03, 32
1A12:08	SubIndex 008	RO	0x6006:04, 32
1A12:09	SubIndex 009	RO	0x6007:01, 32
1A12:0A	SubIndex 010	RO	0x6007:02, 32
1A12:0B	SubIndex 011	RO	0x6007:03, 32
1A12:0C	SubIndex 012	RO	0x6007:04, 32

To ensure that no samples are lost due to the asynchronous nature between the master cycle and slave cycle, the master cycle time optoNCDT 1900 / EtherCAT

should always be less than the time for building a block from  $n$  samples.

An entire block with the specified samples is only made available to the EtherCAT side after all specified samples have been written to the block. If the time for filling a block is less than the master cycle time, individual blocks are not transferred. It can indeed happen that the next block is already being filled with samples before the previously filled block is picked up in a master cycle.

Time for  $n$  samples < master cycle time

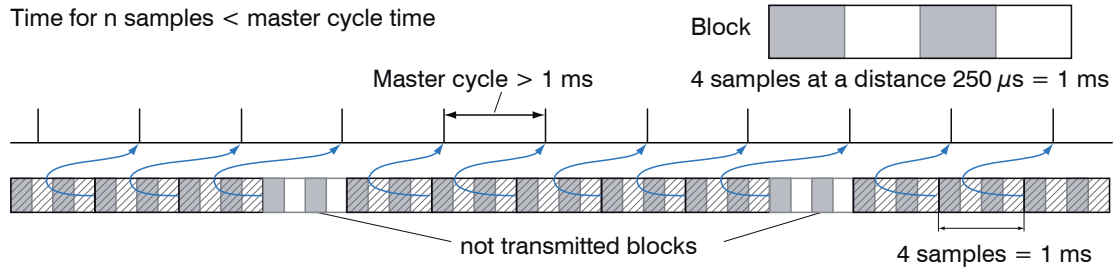

But if you select a number of samples sufficiently large so that the time for filling a block is greater than the master cycle time, each block will be picked up in a master cycle. Individual blocks (and therefore samples), however, will be transferred two or more times. This can be detected on the master side by transferring the timestamp or value counter (see object 0x6002, 0x6003).

Time for  $n$  samples  $>$  master cycle time

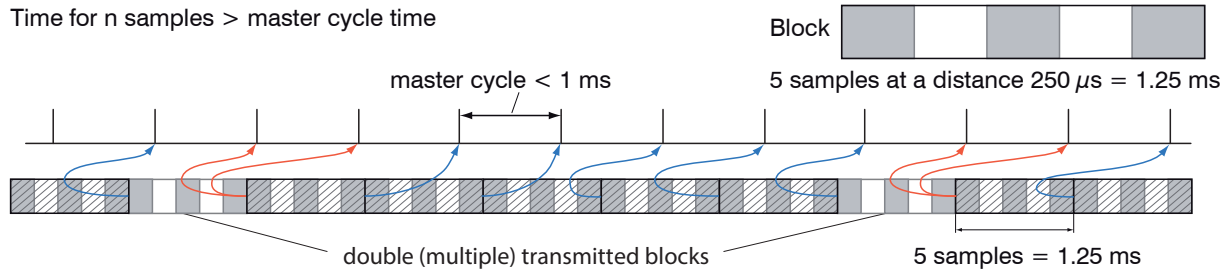



## A 5.7 Update

To update the firmware of the sensor, two options are available:

- Update via EoE (Ethernet over EtherCAT) or Telnet
- Update via FoE (File Access over EtherCAT)

### A 5.7.1 Update via FoE

Via FoE it is possible to perform an update of the sensor. For this purpose, a \*.mef file is transferred to the sensor via FoE. The name and password of the file are as follows:

Name: `optoNCDT_1900.mef`

Password: `0x00000000`

The sensor checks the beginning of the file during transmission. If the file is not in the correct format, the sensor will abort the transfer. After the file has been completely transferred, the sensor automatically starts the update, which disconnects the EtherCAT master.

### A 5.7.2 Update via EoE

An update is performed via a \*.meu file. The firmware update tool `Update_Sensor.exe` is required for this.

The current firmware is available at [www.micro-epsilon.de/service/download/software](http://www.micro-epsilon.de/service/download/software).

To execute an update, you have to check `Ethernet` in the firmware update tool and enter the IP address, which you have configured via the EtherCAT master. With `Refresh` you can check if the sensor can be found on this IP address. Then select the \*.meu file via "..."  
and confirm with `Send update`. First, the update is transmitted to the sensor. After transmission has been completed, the installation will start automatically. Do not disconnect the sensor from the power supply. After the installation is complete, the message `All updates successful` is displayed. Sensor is ready for operation again.

## **A 5.8 Operational Modes**

### **A 5.8.1 Free Run**

There is no synchronization between sensor and EtherCAT master. The PDOs are updated based on the internal measuring rate. The measuring rate is set using object 0x3200:003. PDO frames may be lost or duplicated. A gapless transmission of the PDO frames to the EtherCAT master is only given if oversampling and measuring rate are in the right relation to the bus cycle, see Chap. [A 5.6](#). You can use the measured value counter in 0x6003 so that measured values are not evaluated twice due to the missing synchronization.

### **A 5.8.2 Distributed Clocks SYNC0 Synchronization**

There is a synchronization between sensor and EtherCAT master via the Sync0 cycle time. An update of the PDOs is done based on the Sync0 cycle time, which replaces the internal measuring rate. In this mode, an EtherCAT master can synchronize the measurement acquisition for the EtherCAT cycle time and the measurement acquisition of multiple controllers.

Note that although the measurements in the sensor are synchronized to the Sync0 cycle time, the transmission of the values to the EtherCAT master is again asynchronous with the bus cycle. Synchronous transmission of the values to the EtherCAT master is only given if oversampling and Sync0 cycle time are in the right relation to the bus cycle, see Chap. [A 5.6](#).

The ESI file contains predefined SYNC0 cycle times. But you can set any cycle time between 100000 ns (measuring rate=10.0 kHz) and 4000000 ns (measuring rate=0.25 kHz).

### **A 5.8.3 SM2/SM3 Synchronization**

The sensor supplies current data to the EtherCAT master with every SM2 or SM3 event. Please note that the data of the PDOs are updated with the internal measuring rate independent of the bus cycle. This can cause PDO frames to be lost or duplicated. A gapless transmission of the PDO frames to the EtherCAT master is only given if oversampling and measuring rate are in the right relation to the bus cycle, see Chap. [A 5.6](#).

### A 5.9 Meaning of RUN and ERR LEDs in EtherCAT Operation

<b>RUN LED</b>	<b>Meaning</b>	
	Green off	INIT state
	Green flashing 2.5 Hz	PRE-OP status
	Green single flash, 200 ms ON / 1000 ms OFF	SAFE-OP status
	Green on	OP status
<b>LED ERR</b>	<b>Meaning</b>	
	Red off	No error
	Red flashing 2.5 Hz	Invalid configuration
	Red single flash, 200 ms ON / 1000 ms OFF	Not requested status change
	Red double flash, 200 ms ON / 200 ms OFF 200 ms ON 400 ms OFF	Timeout of the watchdog
	Red flashing 10 Hz	Error by initializing

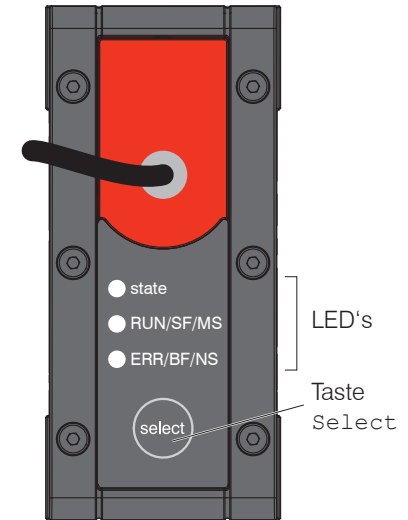

### A 5.10 EtherCAT Configuration with the Beckhoff TwinCAT® Manager

As EtherCAT master on the PC, e.g. the TCXAEShell software from Beckhoff can be used.

This section requires that

- the TwinCAT XAE Shell software is installed on your PC,
- a sensor is connected to the PC via LAN,
- no TwinCAT project has been created.

The device description file (EtherCAT®-Slave Information) `Micro-Epsilon_optoNCDT_19xx.xml` can be found online at <https://www.micro-epsilon.com/download/software>.

- Copy the device description file to the directory `C:\TwinCAT\3.1\Config\Io\EtherCAT` before the measuring device can be configured via EtherCAT®.
- Delete any existing older files.

EtherCAT®-Slave information files are XML files, which specify the characteristics of the Slave device for the EtherCAT® Master and contain information on the supported communication objects.

- Start the TwinCAT XAE Shell program.
- Create a new project by clicking the New TwinCAT Project button.

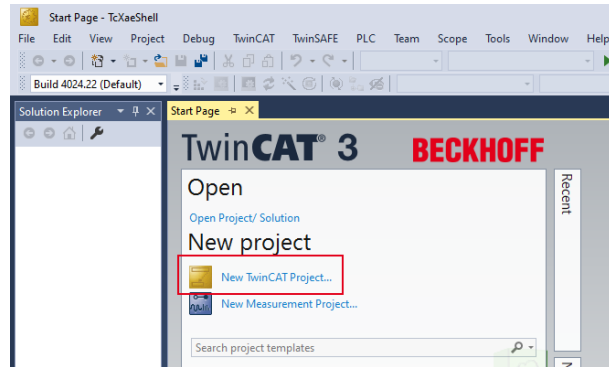

- Assign a name for the project and choose a suitable location.
- Confirm with **OK**.

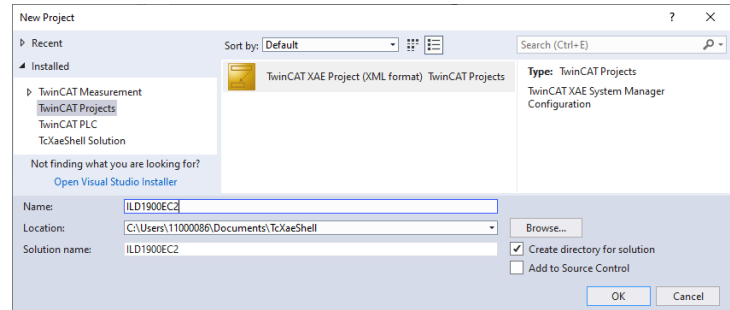

### Searching for a device:

- Switch to the **Solution Explorer** window. In the **I/O** tab, right-click on the **Devices** entry, and then **Scan**.
- Confirm with **OK**.

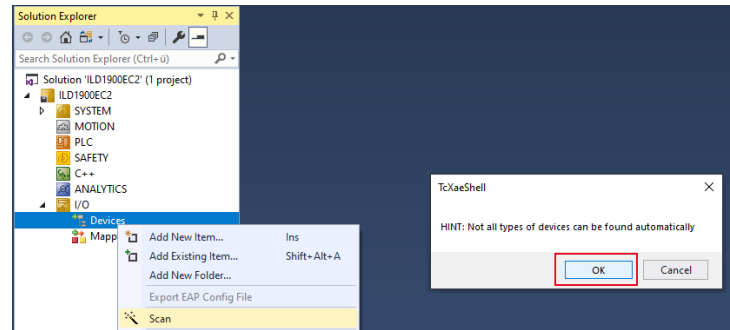

- Select a network card at which EtherCAT® slaves are to be searched for.
- Confirm with **OK**.

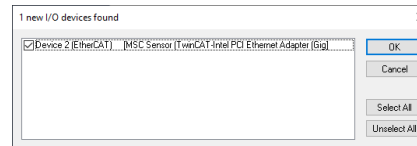

The “Scan for boxes” window appears (EtherCAT® slaves).

- Confirm with **Yes**.

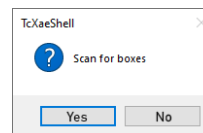

The sensor is now listed in the device list, see [Solution Explorer window](#).

➡ Now confirm the `Activate Free Run` window with `Yes`.

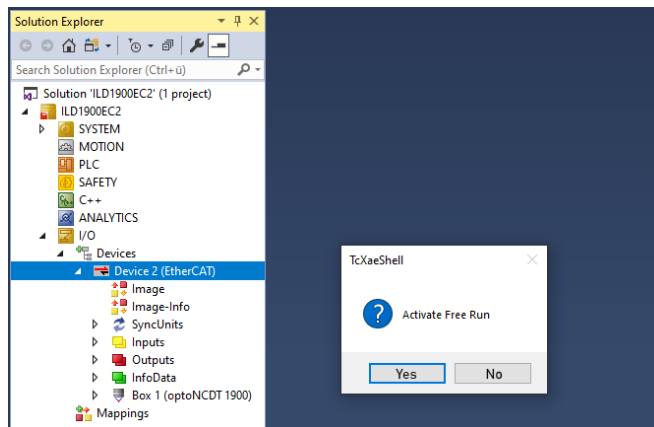

The current status should be at least `PREOP`, `SAFEOP` or `OP` on the `Online` page.

In the event that `ERR PREOP` appears in `Current Status`, the cause is reported in the message window. This will be the case if the settings for the PDO mapping in the controller are different from the settings in the ESI file (`Micro-Epsilon_optoNCDT_19xx.xml`).

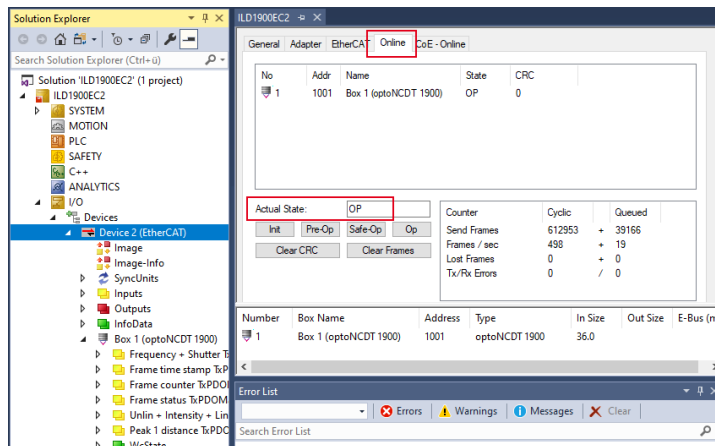

You can select other data in the `Process Data` tab.

The screenshot displays the TwinCAT configuration environment. On the left, the Solution Explorer shows the project structure for 'ILD1900EC2', with 'Box 1 (optoNCDDT 1900)' selected under 'I/O' > 'Devices' > 'Device 2 (EtherCAT)'. The main window shows the 'Process Data' tab for 'Sync Manager'.

**Sync Manager:**

SM	Size	Type	Flags
0	1024	MbxOut	
1	1024	MbxIn	
2	0	Outputs	
3	36	Inputs	

**PDO Assignment (0x1C13):**

Download

PDO Assignment

PDO Configuration

**PDO List:**

Index	Size	Name	Flags	SM	SU
0x1A00	8.0	Frequency + Shutter TxPDOMap OV1	F	3	0
0x1A01	16.0	Frequency + Shutter TxPDOMap OV2	F	0	0
0x1A02	32.0	Frequency + Shutter TxPDOMap OV4	F	0	0
0x1A04	4.0	Frame time stamp TxPDOMap OV1	F	3	0
0x1A05	8.0	Frame time stamp TxPDOMap OV2	F	0	0
0x1A06	16.0	Frame time stamp TxPDOMap OV4	F	0	0
0x1A08	4.0	Frame counter TxPDOMap OV1	F	3	0
0x1A09	8.0	Frame counter TxPDOMap OV2	F	0	0

**PDO Content (0x1A00):**

Index	Size	Offs	Name	Type	Default (hex)
0x6000:01	4.0	0.0	SubIndex 001	UDINT	
0x6001:01	4.0	4.0	SubIndex 001	UDINT	
		8.0			

**Predefined PDO Assignment: (none)**

Load PDO info from device

**Sync Unit Assignment...**

Name	Online	Type	Size	> Addr...	In/Out	User ID	Linked to
SubIndex 001	54	UDINT	4.0	39.0	Input	0	
SubIndex 001_1	5000	UDINT	4.0	43.0	Input	0	
SubIndex 001	379915313	UDINT	4.0	47.0	Input	0	
SubIndex 001	23374312	UDINT	4.0	51.0	Input	0	
SubIndex 001	256	UDINT	4.0	55.0	Input	0	
SubIndex 001	110380	UDINT	4.0	59.0	Input	0	
SubIndex 001_1	471	UDINT	4.0	63.0	Input	0	
SubIndex 001_2	26654	UDINT	4.0	67.0	Input	0	

The scope of the provided process data and the assignment of the SyncManager may be viewed now.

▶ Go to the TwinCAT menu and select the Restart TwinCAT (Config Mode) entry.

The configuration is now complete.

In SAFEOP and OP status, the selected measurement values are transferred as process data.

The screenshot displays the EtherCAT software interface. On the left, the Solution Explorer shows a project tree with the following structure:

- Image-Info
- SyncUnits
- Inputs
- Outputs
- InfoData
- Box 1 (optoNCDT 1900)
  - Frequency + Shutter TxPDOMap OV1
  - Frame time stamp TxPDOMap OV1
  - Frame counter TxPDOMap OV1
  - Frame status TxPDOMap OV1
  - Unlin + Intensity + Lin TxPDOMap OV1
  - Peak 1 distance TxPDOMap OV1
    - SubIndex 001
  - WcState

The right pane shows the details for the selected 'SubIndex 001' variable:

Name	[X]	Online	Type	Size	>Addr...	In/Out	Linked to
SubIndex 001		124509	UDINT	4,0	71.0	Input	

Below the variable details, the Error List window is visible, showing a search bar and filter buttons for Errors, Warnings, Messages, and Clear.







MICRO-EPSILON MESSTECHNIK GmbH & Co. KG

Königbacher Str. 15 · 94496 Ortenburg/Germany

Phone +49 8542 / 168 0 · Fax +49 8542 / 168 90

info@micro-epsilon.com · www.micro-epsilon.com

Your local contact: [www.micro-epsilon.com/contact/worldwide/](http://www.micro-epsilon.com/contact/worldwide/)

X9751444-A012062MSC

© MICRO-EPSILON MESSTECHNIK