



Quick Manual
confocalDT IFD2410/2415
EtherCAT

IFD2410-1
IFD2410-3
IFD2410-6

IFD2415-1
IFD2415-3
IFD2415-10

Contents

General	3	Access via Web Interface	14
Symbols Used	3	Positioning the Target	15
Warnings	3	Presets, Setups, Measurement Configuration, Signal Quality ...	16
Intended Use	4	Checking the Video Signal, Peak Selection	18
Proper Environment	4	Distance Measurement with Website Display	19
Glossary	4	One-Sided Thickness Measurement, Transparent Target	21
Mechanical Fastening	5	Preset Selection	21
Preliminary Remarks	5	Material Selection	21
Circumferential Clamping	5	Video Signal	22
Direct fastening	6	Measurement Chart for Thickness Measurement	23
Electrical Connections	7	Switch between Ethernet Setup Mode and EtherCAT	24
Supply Voltage	9	EtherCAT	25
RS422 Connection with USB Converter IF2001/USB	9	Preliminary Remarks	25
Sensor LEDs	10	Parameter Setting via EtherCAT	25
Correct Button	11	Saving the Settings, Continuing EtherCAT Mode	26
Start of Measuring Range	11	Service, Repair	27
Initial Operation	12	Disclaimer	27
Switch between EtherCAT and Ethernet Setup Mode	13	Decommissioning, Disposal	28

MICRO-EPSILON
MESSTECHNIK
GmbH & Co. KG
Koenigbacher Str. 15

94496 Ortenburg / Germany

Tel. +49 (0) 8542 / 168-0
Fax +49 (0) 8542 / 168-90
e-mail info@micro-epsilon.com
www.micro-epsilon.com



EtherCAT® is registered trademark
and patented technology, licensed by
Beckhoff Automation GmbH, Germany.

You can find more information about the measuring system
in the operating instructions. They are available online at:

[www.micro-epsilon.de/download/manuals/man-
confocalDT-2410-2411-2415--en.pdf](http://www.micro-epsilon.de/download/manuals/man-confocalDT-2410-2411-2415--en.pdf)



General

Symbols Used

The following symbols are used in this document:



Indicates a hazardous situation which, if not avoided, may result in minor or moderate injury.



Indicates a situation that may result in property damage if not avoided.



Indicates a user action.

i

Indicates a tip for users.

Measurement

Indicates hardware or a software button/menu.

Warnings



Connect the power supply and the display/output device according to the safety regulations for electrical equipment.

> Risk of injury, damage to or destruction of the sensor

When all interfaces are used, the sensor surface heats up to more than 50 °C.

> Risk of injury



Avoid shocks and impacts to the sensor.

> Damage to or destruction of the sensor

The supply voltage must not exceed the specified limits.

> Damage to or destruction of the sensor

Protect the cables against damage.

> Failure of the measuring device

Intended Use

- The measuring system is designed for use in an industrial environment. It is used for
 - displacement, distance, movement and thickness measurement,
 - measuring the position of parts or machine components
- The measuring system must only be operated within the limits specified in the technical data.
- ➡ The measuring system must only be used in such a way that no persons are endangered or machines are damaged in the event of malfunction or total failure of the sensor.
- ➡ Take additional precautions for safety and damage prevention in case of safety-related applications.

Proper Environment

- Sensor protection class: IP64, front side
- Operating temperature range: +5 ... +50 °C
- Temperature range (storage): -20 ... +70 °C
- Humidity: 5 ... 95% (non-condensing)
- Ambient pressure: Atmospheric pressure
- Shock (DIN EN 60068-2-27): 15 g / 6 ms in XY-axis, 1000 shocks each
- Vibration (DIN EN 60068-2-6): 2 g / 20 ... 500 Hz in XY-axis, 10 cycles each

Glossary

SMR Start of measuring range

MMR Mid of measuring range

MR Measuring range

EMR End of measuring range

Minimum target thickness see Technical Data, Operating Instructions

Maximum target thickness Sensor measuring range x Refractive index of target

Mechanical Fastening

Preliminary Remarks

IFD241x optical sensors operate in the μm range. Observe the maximum tilt angle between sensor and target.

- Ensure careful handling during installation and operation!

Circumferential Clamping

► Use an adapter to mount the IFD241x sensors.



Circumferential clamping with MA240x mounting ring, consisting of mounting block and mounting ring

- Micro-Epsilon recommends circumferential clamping

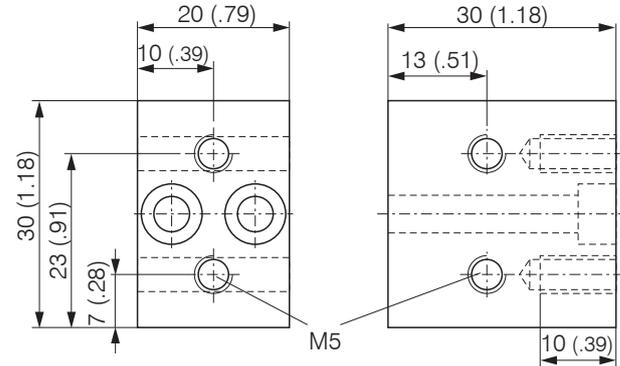

Dimension in mm (inch)

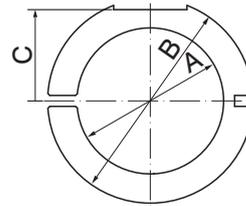

Mounting ring	Size A	Size B	Size C
MA2400-27	$\varnothing 27$	$\varnothing 46$	19.75 (.78)
MA2405-34	$\varnothing 34$	$\varnothing 50$	22 (.87)
MA2405-54	$\varnothing 54$	$\varnothing 70$	32 (1.26)

Mounting block and MA240x mounting ring

Direct fastening

► Mount the sensor via three M3 screws.

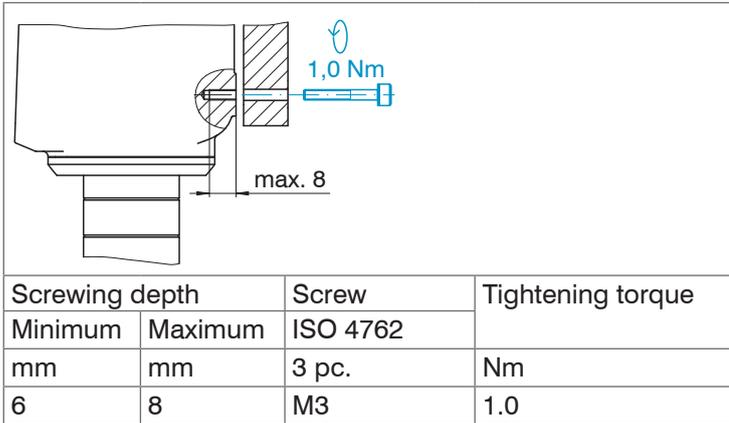

Mounting conditions

IFD2410-	1	3	6
MR	1	3	6
SMR	15	25	35
A	56		
B	33		
C	150		
D	27		

IFD2415-	1	3	10
MR	1	3	10
SMR	10	20	50
A	82	85	118
B	59	62	---
C	176	179	212
D	27	34	54

Dimensions in mm

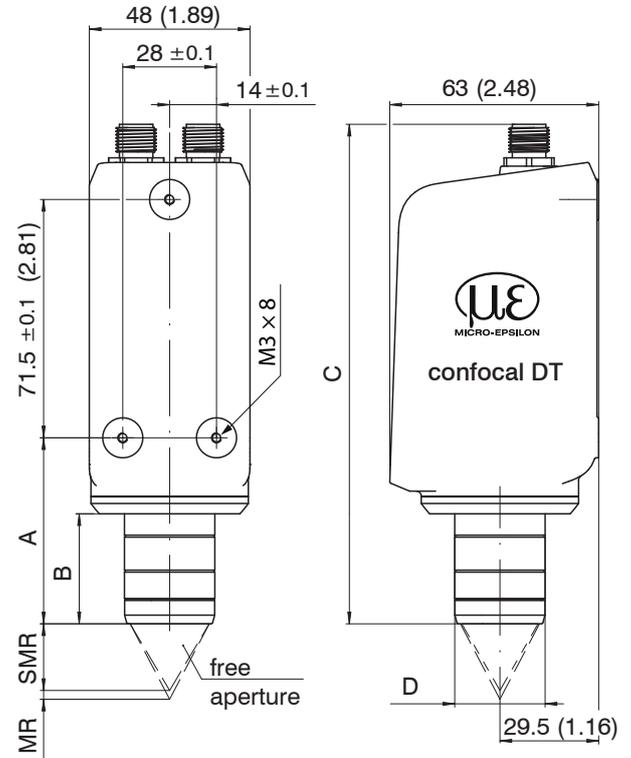

Dimensional drawing IFD2410 / IFD2415

Dimension in mm (inch)

The bearing surfaces surrounding the mounting holes are slightly raised.

Electrical Connections

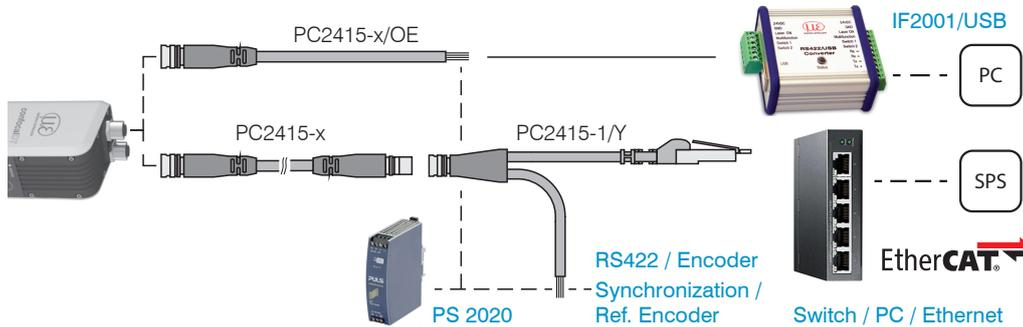

The PC2415-1/Y cable is included in delivery.

Characteristics PC2415-1/Y:

- Power supply
- Ethernet
- RS422 and synchronization or encoder

Other cables are available as optional accessory.

12-pin connector sensor			PC2415-x/OE	PC2415-1/Y	IF2001	
Signal		Pin	Wire color	Wire color	RJ45, Pin	Signal
V ₊		1	Red	Red	---	24VDC
Supply GND		2	Blue	Blue	---	GND
Data Rx+	Encoder 2A+ ¹	3	Brown	Brown	---	Tx+
Data Rx-	Encoder 2A-	4	White	White	---	Tx-
Data Tx+	Encoder 2B+	5	Green	Green	---	Rx+
Data Tx-	Encoder 2B-	6	Yellow	Yellow	---	Rx-
SYNC+	Encoder 2Ref+	7	Gray	Gray	---	---
SYNC-	Encoder 2Ref-	8	Pink	Pink	---	---
Industrial Ethernet		9	White/Green	---	3	---
		10	Green	---	6	---
		11	White/Orange	---	1	---
		12	Orange	---	2	---

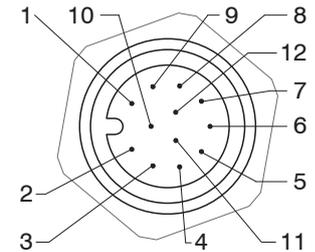

12-pin sensor connector, pin side

- 1) You can use the pins for
- serial communication TIA/EIA-422-B) and synchronization or
 - for encoder signals.

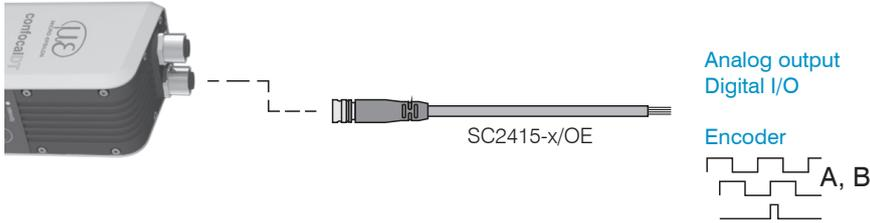

17-pin connector sensor		SC2415-x/OE
Signal	Pin	Wire color
Analog output	1	White, internal
Analog GND	2	Black ¹
Switching output 2 GND	3	Black
Switching output 2	13	Purple
Multifunction input 1	5	Red
Multifunction input 2	14	Blue
Encoder 1B+	8	Gray
Encoder 1B-	15	Pink
Encoder 1Ref+	9	Green
Encoder 1Ref-	16	Yellow
Switching output 1 GND	10	Brown
Switching output 1	11	White
Encoder 1A-	12	Red/Blue
Encoder 1A+	17	Gray/Pink

1) Analog output in shielded cable area

Characteristics SC2415-x/OE:

- Analog output
- Switching outputs
- Encoder

The SC2415-x/OE cable is optionally available.

The GND connections of the switching outputs are separated from supply GND by filters.

The GND connections of the switching outputs are separated from analog GND by filters.

The GND connections are not electrically separated.

i For reasons of interference immunity, use the associated GND connection for the analog output and the two switching outputs.

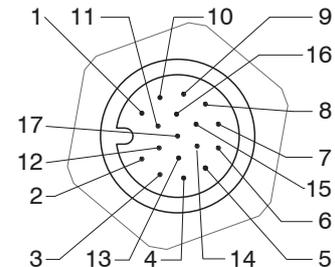

17-pin sensor connector, pin side

Supply Voltage

Nominal value: 24 V DC (20 ... 28 V, $P < 7 \text{ W}$)

Sensor supply is via the PC2415-1/Y or PC2415-x/OE cable.

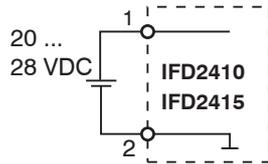

Sensor 12-pin connector	Power supply	PC2415-1/Y PC2415-x/OE
1	V_+	Red
2	GND	Blue

Voltage supply only for measuring devices, not to be used for drives or similar sources of impulse interference at the same time. MICRO-EPSILON recommends using an optional available power supply unit PS2020 for the sensor.

- Only turn on the power supply after wiring has been completed.
- Connect the inputs Pin 1 and Pin 2 at the sensor with a 24V power supply.

RS422 Connection with USB Converter IF2001/USB

In addition to Industrial Ethernet, the sensor also supports serial communication via RS422. Serial communication is possible with PC2415-1/Y or PC2415-x/OE cables. The IF2001/USB is available as an optional accessory.

Properties: Differential signals according to EIA-422, galvanically connected to the supply voltage.

- Use a shielded cable with twisted wires.
Cable length less than 30 m.
- Connect the ground connections.

Sensor 12-pin connector	Signal	PC2415-1/Y PC2415-x/OE	IF2001/USB
3	RX +	Brown	TX +
4	RX -	White	TX -
2	Supply GND (Blue)		
5	TX +	Green	RX +
6	TX -	Yellow	RX -
Housing	Shield	Cable shield	---

Sensor LEDs

LED	Color	Status	Meaning
Intensity	Red	flashes	Dark signal acquisition in progress
	Red	lights up	Signal saturated
	Yellow	lights up	Signal too low
	Green	lights up	Signal OK
Range	Red	flashes	Dark signal acquisition in progress
	Red	lights up	No target present, outside of measuring range
	Yellow	lights up	Target close to mid of measuring range
	Green	lights up	Measuring object within the measuring range
RUN	Green	Off	Slave is in the "Init" status
	Green	flashes evenly	Slave is in the "Pre-Operational" status
	Green	flashes briefly	Slave is in the "Safe-Operational" status
	Green	flashes quickly	Slave is in the "initialization" or "bootstrap" status
	Green	lights up	Slave is in the "Operational" status
ERR	Red	Off	No error
	Red	flashes evenly	Invalid configuration
	Red	flashes briefly	Unwanted status change
	Red	flashes twice	Timeout of the Application watchdog
	Red	flickers	Boot error
	Red	lights up	Timeout of the PDI watchdog

 intensity

 range

 RUN / SF / MS

 ERR / BF / NS

Correct Button

The **Correct** button is assigned multiple functions. As standard, the button is assigned the dark reference function.



Function	Dark reference	<i>Starts dark referencing</i>
	Factory setting	Reset the device and measurement settings to factory settings.

The selected function is indicated by the flashing/illuminated **Range** and **Intensity** LEDs.

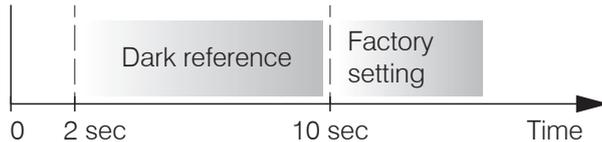

Correct button actuation time

The **Correct** button is not assigned a key lock in the factory. Optionally, you can deactivate or lock the **Correct** button, see the operating instructions for the sensor.

With the **Correct** key you can also change the operation mode. For details, refer to section **Initial Operation** or **Switch between EtherCAT and Ethernet Setup Mode**.

Start of Measuring Range

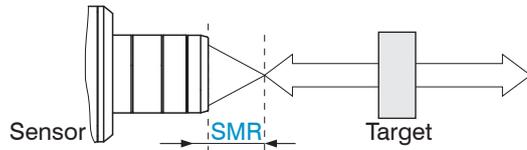

An offset distance (SMR) between the sensor and the target must be kept.

Start of measuring range (SMR), the shortest distance between the front surface of the sensor and the target

Initial Operation

- The measuring system is ready for operation approx. 3 s after applying the supply voltage.
- ! To ensure precise measurements, let the measuring system warm up for approx. 50 minutes.

The controller starts in the last stored operating mode. Standard is EtherCAT.

Ethernet-Setup-Mode

- Programming via web interface,
- no EtherCAT

➡ Switch to the Ethernet setup mode.

Details can be found in section *Switch between EtherCAT and Ethernet Setup Mode*.

- ➡ Connect the sensor and the PC with a LAN cable.
- ➡ Start your web browser and type the standard IP address 169.254.168.150 of the sensor into the address bar.

Alternative communication with the sensor

RS422 Communication

- Programming via web interface;
- programming on command level e.g. with Telnet,
- no parallel output of measurement data via EtherCAT and RS422 possible

➡ Connect the sensor, e.g. via an IF2001/USB RS422 converter from Micro-Epsilon via USB to a PC.

➡ Start the `sensorTOOL` program.

Download at <https://www.micro-epsilon.de/download/software/sensorTOOL.exe>.

➡ Click the `Sensor` button.

The program will now search for connected sensors.

➡ Select a desired sensor. Click the `Open Website` button.

Ethernet over EtherCAT (EoE)

- Programming via web interface;
- programming on command level e.g. with Telnet,
- Parallel programming and measurement

➡ Enable the EoE in your PLC software.

➡ Assign a MAC address and an IP address to the slave.

Saved settings remain in the sensor remanently across interfaces

Switch between EtherCAT and Ethernet Setup Mode

The sensor starts in the last stored operating mode. Factory setting is EtherCAT. Access via Ethernet is possible in the Ethernet setup mode.

➡ Press and hold the `Correct` button on the sensor before switching on the power supply on the sensor. Release the button again as soon as the `Intensity` LED flashes yellow. Press the button again for approx. 10 to 15 seconds until the `Intensity` LED flashes red.

Within the time $t_2 \dots t_3$, the red flashing with 8 Hz starts after 10 seconds. The key must be released again after 15 seconds at the latest. When the `Correct` key is released at the latest at time t_3 , the `Intensity` LED starts to flash yellow at 8 Hz.

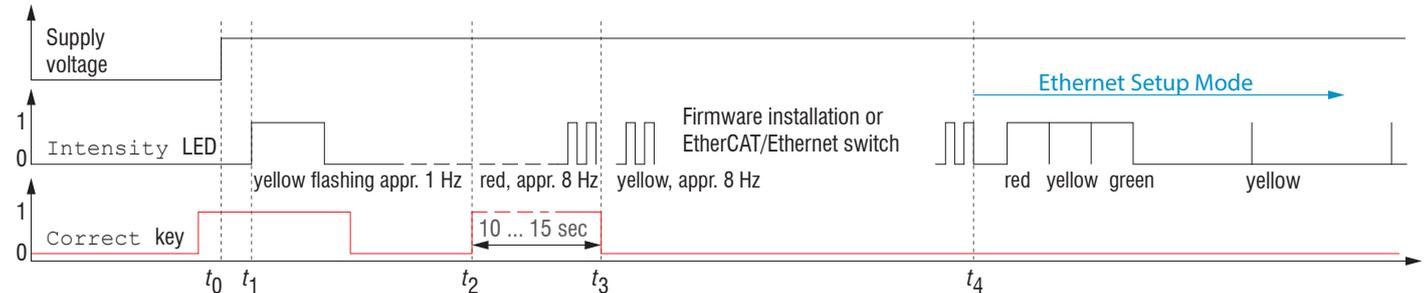

Flowchart for starting a sensor in Ethernet setup mode

After completion of the firmware installation/switch, the sensor reboots at time t_4 .

t_0 : Supply voltage is applied

t_1 : The `Intensity` LED starts flashing yellow, the `Correct` button can be released

t_2 : Within 15 sec. ($t_2 - t_1$), press `Correct` button again and hold for further 10 ... 15 sec. ($t_3 - t_2$)

$t_3 \dots t_4$: Switches from EtherCAT to Ethernet Setup Mode, duration max. 1 min.

t_4 : Sensor starts in Ethernet setup mode, the `Intensity` LED lights up briefly at intervals of approx. 1 sec.

Access via Web Interface

▶ Start the web interface of the sensor, see section *Initial Operation*.

Interactive web pages you can use to configure the sensor are now displayed in the web browser. The sensor is active and supplies measurement values. The web interface does not guarantee real-time measurements. The currently running measurement can be controlled using the function buttons in the `Chart` type section.

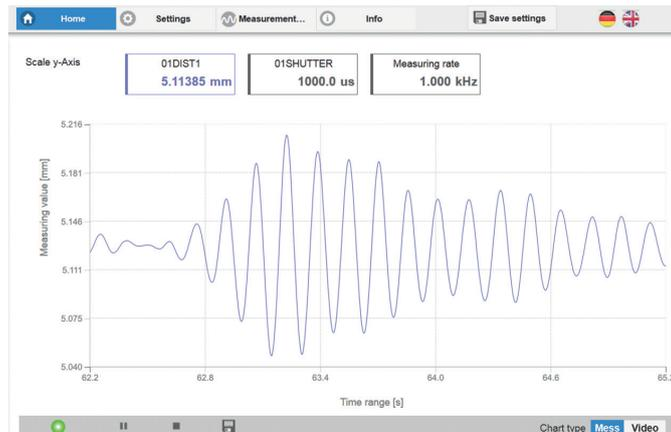

First page after web interface has been accessed in Ethernet mode

For configuration, you can switch between the video signal and a display of the measured values over time. The appearance of the websites depends on the functions. Dynamic help texts with excerpts from the operating instructions supports you during sensor configuration.

• Depending on the selected measuring rate and the PC used, measured values may be reduced in the display. That is, not all measured values are transmitted to the web interface for display and saving.

The horizontal navigation includes the functions below:

- Home. The web interface automatically starts in this view with Measurement Chart, Measurement configuration and Signal quality.
- Settings. Sensor parameters configuration such as triggering, measuring rate and zero setting/mastering.
- Measurement chart. Measurement chart or video signal display.
- Info. Includes information about the sensor, such as measuring range, serial number and software status.

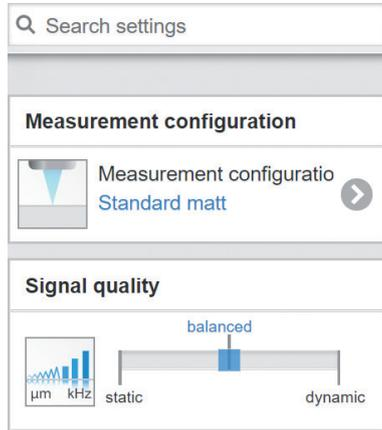

The vertical navigation is contextual to the selection in the horizontal navigation and contains the following functions for the Home menu:

- The `Search settings` function permits time-saving access to functions and parameters.
- `Measurement configuration`. Allows a selection of predefined measurement settings.
- `Signal quality` By mouse click it is possible to switch between three predefined basic settings for the measuring rate and the averaging.

Positioning the Target

➡ Position the target as centrally as possible within the measuring range.

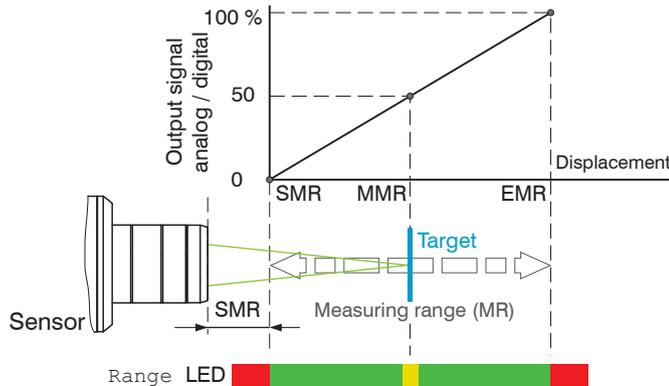

- intensity
- range

Range LED	
Red	No target present or target outside of measuring range
yellow	Target close to mid of measuring range
green	Measuring object within the measuring range

The **Range LED** on the front of the sensor indicates the position of the target relative to the sensor.

Presets, Setups, Measurement Configuration, Signal Quality

Definition

- Preset: Manufacturer-specific program with settings for frequent measurement tasks; cannot be overwritten
- Setup: User-specific program with relevant settings for a measurement task
- Initial setup at boot (sensor start): a favorite can be selected from the setups, which is automatically activated at sensor start. If no favorite is determined from the setups, the sensor activates the *Standard* preset at startup.

Measurement configuration

Measurement configuration
Standard matt

Signal quality

balanced

static dynamic

System configuration

Measuring rate
1.0

Exposure mode
Measurement mode

Number of peaks
1 measurement values: High

Output interface
Analog output

Measurement configuration

Presets

Standard matt

Standard shiny

Multisurface

One-sided thickness measurement

Setups

F14_8_07

F2_1_34

Upon delivery of the sensor from the factory

- the presets *Standard matt*, *Standard shiny*, *Multisurface* and *One-sided thickness measurement* are possible
- for the IFD2415 sensor, the presets *Multilayer air gap* and *Multilayer laminated glass* are available.
- no setup is available.

You can select a preset in the tab

Home > Measurement configuration

You can select a setup in the tab

Home > Measurement configuration **or**
Settings in the System settings > Load & save
menu

A setup can be stored permanently in the sensor.

For all presets, the measurement task can be individually adapted via the `Signal quality` slider. Reducing the measuring rate increases the exposure time for the line and thus improves the measurement quality.

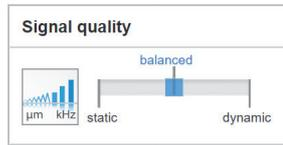

Measuring rate ¹	Averaging ¹
0.2 kHz	Static Moving, 128 values
1 kHz	Balanced Moving, 16 values
5 kHz	Dynamic Moving, 4 values

Description

Three predefined basic settings (Static, Balanced and Dynamic); a change via mouse click is immediately visible in the diagram and the system configuration.

i If the sensor starts up with a user-defined measurement setting (setup), the signal quality cannot be changed.

Presets allow a quick start into the individual measurement task. Basic features such as peak and material selection and the calculation functions are already set in the presets to match the target surface.



Standard matt

Distance measurement, e.g., for ceramic material, non-transparent plastics. Highest peak, averaging, distance calculation.



One-sided thickness measurement

One-sided thickness measurement, e.g., for glass, BK7 material. First and second peak, averaging, thickness calculation.

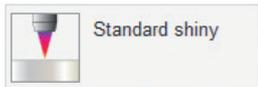

Standard shiny

Distance measurement, e.g., for metal, polished surfaces. Highest peak, Median over 5 values, distance calculation.



Multilayer air gap

One-sided thickness measurement² against glass, 1st layer BK7, 2nd layer vacuum, first and second peak, 3 measured values, median over five values, moving averaging over 16 values, thickness calculation.



Multisurface

Distance measurement, e.g., for PCBs, hybrid materials. Highest peak, Median over 9 values, distance calculation.



Multilayer laminated glass

Layer thickness measurement² against laminated glass e.g. windshield, 1st layer BK7, 2nd layer PC, 3rd layer BK7, first and second peak, 4 measured values, thickness calculation, moving averaging over 16 values.

1) Values apply to the Standard matt and One-sided thickness measurement presets. 2) Possible in IFD2415

Checking the Video Signal, Peak Selection

The video signal shows the determined reflections at the measuring object as a raw signal. The peaks are counted starting at the start of the measuring range toward the end of the measuring range. The corresponding measured value is marked by a vertical line (peak marking).

➤ Go to the **Measurement chart** menu. Display the video signal with **Video**. Adjust the settings for the exposure mode and measuring rate parameters.

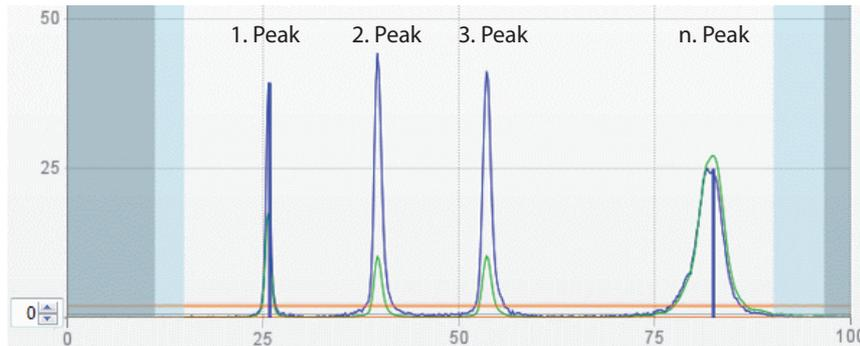

The selection of peaks dictates which region in the signal is used for the distance or thickness measurement. For a measuring object consisting of several transparent layers, use the refractive index correction to compensate for the distance measurement errors caused by optical factors, see operating instructions.

Video signal with four peaks in the measuring range

1 measurement	first peak / highest peak / last peak
2 measurement values	first and second peak / first and last peak / second to last and last peak / highest and second highest peak
3 up to 5 measurement values	All peaks above the intensity threshold are evaluated in ascending distance order.

Options for peak selection

The **Standard**, **Standard shiny** and **Multisurface** presets use the highest peak.

The preset **One-sided thickness measurement** uses the 1. and 2. peak for the calculation of the measured value.

➤ Go to the **Data Recording > Settings > Peak selection** menu to select a different peak.

Distance Measurement with Website Display

➡ Align the sensor perpendicularly to the object to be measured.

➡ Then, move the sensor (or the target) closer and closer to the start of the measuring range of the relevant sensor.

As soon as the object is within the measuring field of the sensor, the sensor's Range LED lights up (green or yellow). Alternatively, you can watch the video signal.



Measurement (*distance measurement*) web page

- 1 **Stop** pauses the chart; you can still use the data selection and zoom functions. **Save** opens a Windows selection dialog for the file name and storage location to save the last 10,000 values in a CSV file (separation using semicolon).
- 2 All changes only become effective when you click on the **Save settings** button.
- 3 In the left-hand window, the signals to be displayed can be switched on or off during or after the measurement. Inactive curves are grayed out and can be added by clicking on the check mark. The changes become effective when you save the settings.
You can show or hide the individual signals using the eye symbols . The calculation continues in the background.
 - 01SHUTTER: exposure time
 - 01xINTENSITY: Signal quality of the underlying peak in the video signal
 - 01DIST: Distance signal curve over time
- 4 To scale the axis in the graph for the measured values (y-axis), you can use **Auto** (= automatic scaling) or **Manual** (= manual scaling).
- 5 The current values for distance, exposure time, current measuring rate and time stamp are shown in the text boxes above the graph. Errors are also displayed.
- 6 **Mouseover** function. When the chart has been stopped and you move the mouse over the graph, points on the curve are marked with a circle and the associated values are displayed in the text boxes above the graph. The intensity bars are also updated.
- 7 The peak intensity is displayed as a bar chart.
- 8 **Scaling the x-axis**: During an ongoing measurement, you can use the left-hand slider to enlarge the entire signal (zoom). The time range can also be defined using an input field under the time axis. When the chart has been stopped, the right-hand slider can also be used. You can also move the zoom window with the mouse in the center of the zoom window (four-sided arrow).

One-Sided Thickness Measurement, Transparent Target

The sensor evaluates two signals reflected on the surfaces. Based on these two signals, the sensor calculates the distances from the surfaces and, from this, derives the thickness.

➤ Align the sensor perpendicularly to the object to be measured. Make sure that the target is approximately in the mid of the measuring range ($SMR + 0.5 \times MR$).

i The light beam must strike the surface of the object at a perpendicular angle. Otherwise, measurements might be inaccurate.

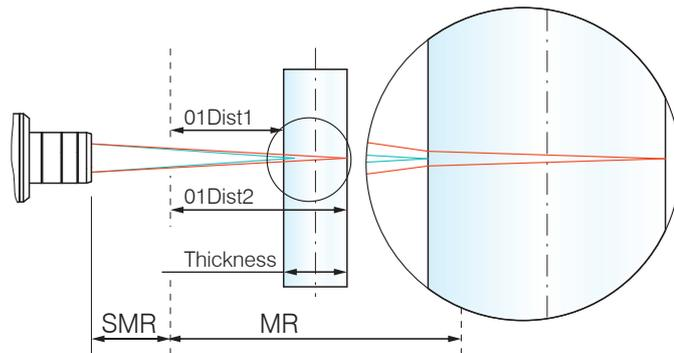

One-sided thickness measurement for a transparent target

Preset Selection

➤ Switch to the Home menu.

➤ Select One-sided thickness measurement in the Measurement configuration menu.

This presetting prompts the sensor to use the first and second peak in the video signal for the thickness calculation.

Material Selection

Specifying the material is essential for calculating a correct thickness value. To compensate for the spectral change of the index of refraction, at least three refractive indices at different wavelengths or a refractive index and the Abbe number must be known.

The material table includes predefined materials.

➤ Switch to the Settings > Data recording > Material selection menu.

➤ Select the material of the target for Layer 1.

Video Signal

If a surface of the target lies outside the measuring range, the sensor will send only one signal for the displacement, intensity and center of gravity. This may also occur if a signal is below the detection threshold. Two boundary surfaces are active when the correct thickness of a transparent material is measured. As a result, two peaks are visible in the video signal.



Video signal (*thickness measurement*) web page

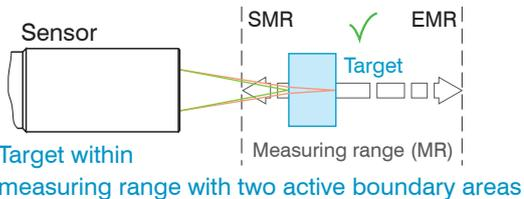

Measurement arrangement thickness measurement

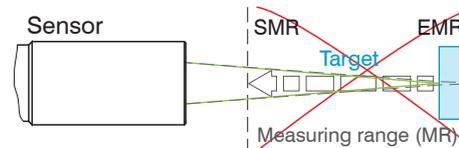
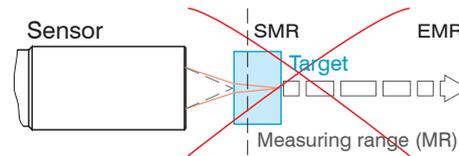

Measuring object only partially in the measuring range

No thickness measurement possible

Measurement Chart for Thickness Measurement

➤ Switch to the `Measurement` chart tab and select `Meas` as the chart type.

The web page shows the two distances and the thickness `Ch01Thick12` (difference between `01DIST2` and `01DIST1`) graphically and numerically. Optionally, the intensities of both peaks (Peak 1 = near, Peak 2 = far) can also be displayed.

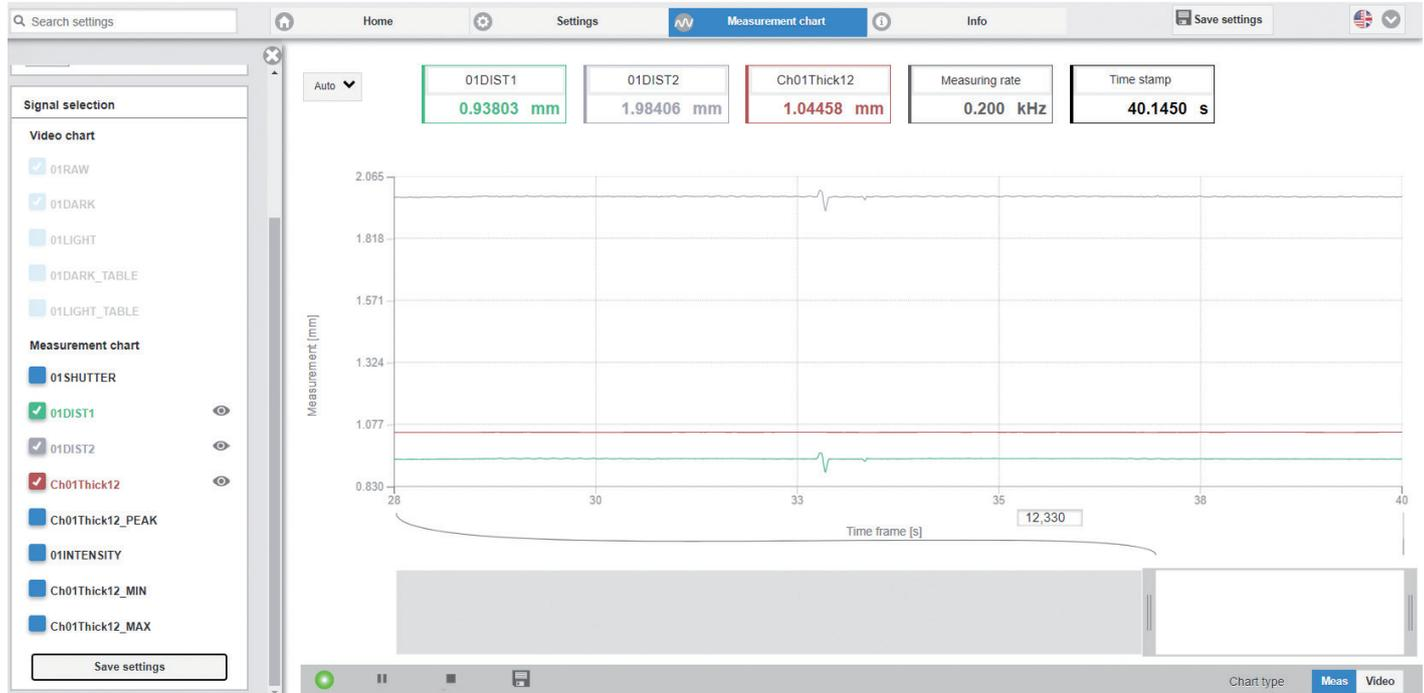

Switch between Ethernet Setup Mode and EtherCAT

The sensors start in the last stored operating mode. With the `Correct` button, you can set the sensor to the EtherCAT operating mode.

▶ Press and hold the `Correct` button on the sensor before switching on the power supply on the sensor. Release the button again as soon as the `Intensity` LED flashes yellow. Press the button again for approx. 10 to 15 seconds until the `Intensity` LED flashes red.

Within the time $t_2 \dots t_3$, the red flashing with 8 Hz starts after 10 seconds. The key must be released again after 15 seconds at the latest. When the `Correct` key is released at the latest at time t_3 , the `Intensity` LED starts to flash yellow at 8 Hz.

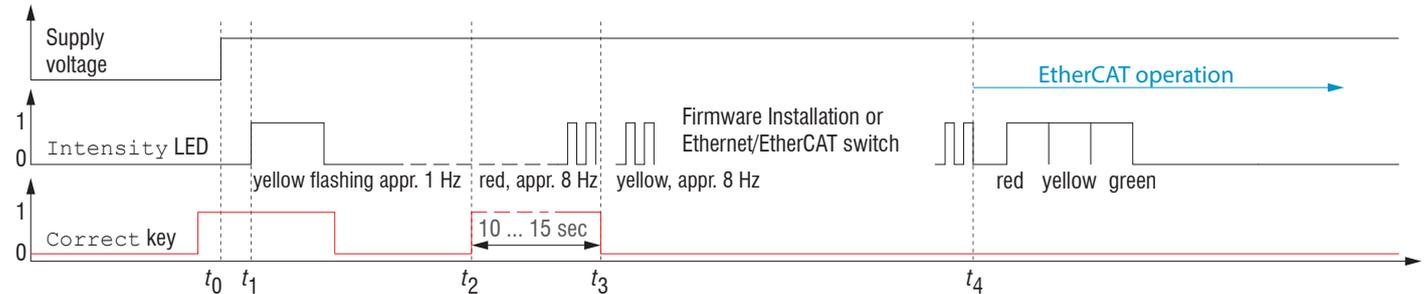

Flowchart for starting a sensor in EtherCAT mode

After completion of the firmware installation/switch, the sensor reboots at time t_4 .

- t_0 : Supply voltage is applied
- t_1 : The `Intensity` LED starts flashing yellow, the `Correct` button can be released
- t_2 : Within 15 sec. ($t_2 - t_1$), press `Correct` button again and hold for further 10 ... 15 sec. ($t_3 - t_2$)
- $t_3 \dots t_4$: Switches from Ethernet Setup Mode to EtherCAT, duration max. 1 min.
- t_4 : Sensor starts in EtherCAT mode.

EtherCAT

Preliminary Remarks

The sensor starts with the last stored operating mode. Default is EtherCAT. You can program the sensor via SDOs. In Ethernet setup mode or with active EoE, programming is alternatively possible via Telnet or the web interface, see the sections Initial Operation, Distance Measurement and One-sided thickness measurement.

Parameter Setting via EtherCAT

The acyclic programming of the sensor is done in EtherCAT via the SDOs of the CANopen protocol. For details about reading and changing SDOs, please refer to the description of your EtherCAT master.

An overview of the available SDOs can be found in the operating instructions of the sensor.

Saving the Settings, Continuing EtherCAT Mode

Programming via SDOs	Programmierung über Webinterface	
	Ethernet-Setup-Mode	Ethernet over EtherCAT (EoE)
<p>Changes to the device settings: ➡ Save the settings with SDO 0x3020:002.</p> <p>Changes to the measurement settings: ➡ Save the settings with sub-index 0x3022:003.</p>	<p>- Programming via web interface</p> <p>➡ Go to Settings > System settings > Load & Save or click the Save settings button.</p> <p>➡ Go to Settings > System settings > Boot mode. Select the entry Industrial Ethernet (EtherCAT).</p> <p>The sensor disconnects from the browser and boots automatically with the EtherCAT firmware. The boot process can take up to one minute.</p> <p>Alternatively, you can return to the EtherCAT mode via the Correct button. Details can be found in section Switch between Ethernet Setup Mode and EtherCAT.</p>	<p>- Programming via web interface or on command level e.g. with Telnet</p> <p>➡ Go to Settings > System settings > Load & Save or click the Save settings button.</p>
<p>➡ Activate the Run mode.</p>		

Continue working in your PLC environment.

Service, Repair

If the sensor is defective:

- If possible, save the current sensor settings in a parameter set to reload them into the sensor after the repair.
- Please send us the affected parts for repair or exchange.

If the cause of a fault cannot be clearly identified, please send the entire measuring system to:

MICRO-EPSILON MESSTECHNIK
GmbH & Co. KG

Koenigbacher Straße 15
94496 Ortenburg / Germany

Tel. +49 (0) 8542 / 168-0

Fax +49 (0) 8542 / 168-90

info@micro-epsilon.com

www.micro-epsilon.com

Disclaimer

All components of the device have been checked and tested for functionality in the factory. However, should any defects occur despite careful quality control, these shall be reported immediately to MICRO-EPSILON or to your distributor/retailer.

MICRO-EPSILON undertakes no liability whatsoever for damage, loss or costs caused by or related in any way to the product, in particular consequential damage, e.g., due to

- non-observance of these instructions/this manual,
- improper use or improper handling (in particular due to improper installation, commissioning, operation and maintenance) of the product, repairs or modifications by third parties,
- the use of force or other handling by unqualified persons.

This limitation of liability also applies to defects resulting from normal wear and tear (e.g., to wearing parts) and in the event of non-compliance with the specified maintenance intervals (if applicable).

MICRO-EPSILON is exclusively responsible for repairs. It is not permitted to make unauthorized structural and / or technical modifications or alterations to the product. In the interest of further development, MICRO-EPSILON reserves the right to modify the design.

In addition, the General Terms of Business of MICRO-EPSILON shall apply, which can be accessed under Legal details | Micro-Epsilon <https://www.micro-epsilon.de/impressum/>.

Decommissioning, Disposal

In order to avoid the release of environmentally harmful substances and to ensure the reuse of valuable raw materials, we draw your attention to the following regulations and obligations:

- Remove all cables from the sensor.
- Dispose of the sensor, its components and accessories, as well as the packaging materials in compliance with the applicable country-specific waste treatment and disposal regulations of the region of use.
- You are obliged to comply with all relevant national laws and regulations

For Germany / the EU, the following (disposal) instructions apply in particular:

- Waste equipment marked with a crossed garbage can must not be disposed of with normal industrial waste (e.g. residual waste can or the yellow recycling bin) and must be disposed of separately. This avoids hazards to the environment due to incorrect disposal and ensures proper recycling of the old appliances.
- A list of national laws and contacts in the EU member states can be found at https://ec.europa.eu/environment/topics/waste-and-recycling/waste-electrical-and-electronic-equipment-weee_en. Here you can inform yourself about the respective national collection and return points.
- Old devices can also be returned for disposal to MICRO-EPSILON at the address given in the imprint at <https://www.micro-epsilon.de/impressum/>.
- We would like to point out that you are responsible for deleting the measurement-specific and personal data on the old devices to be disposed of.
- Under the registration number WEEE-Reg.-Nr. DE28605721, we are registered at the foundation Elektro-Altgeräte Register, Nordostpark 72, 90411 Nuremberg, as a manufacturer of electrical and/or electronic equipment.



MICRO-EPSILON MESSTECHNIK GmbH & Co. KG
Koenigbacher Str. 15 · 94496 Ortenburg / Germany
Tel. +49 (0) 8542 / 168-0 · Fax +49 (0) 8542 / 168-90
info@micro-epsilon.com · www.micro-epsilon.com

Your local contact: www.micro-epsilon.com/contact/worldwide/

X9691458-A022103MSC

© MICRO-EPSILON MESSTECHNIK