

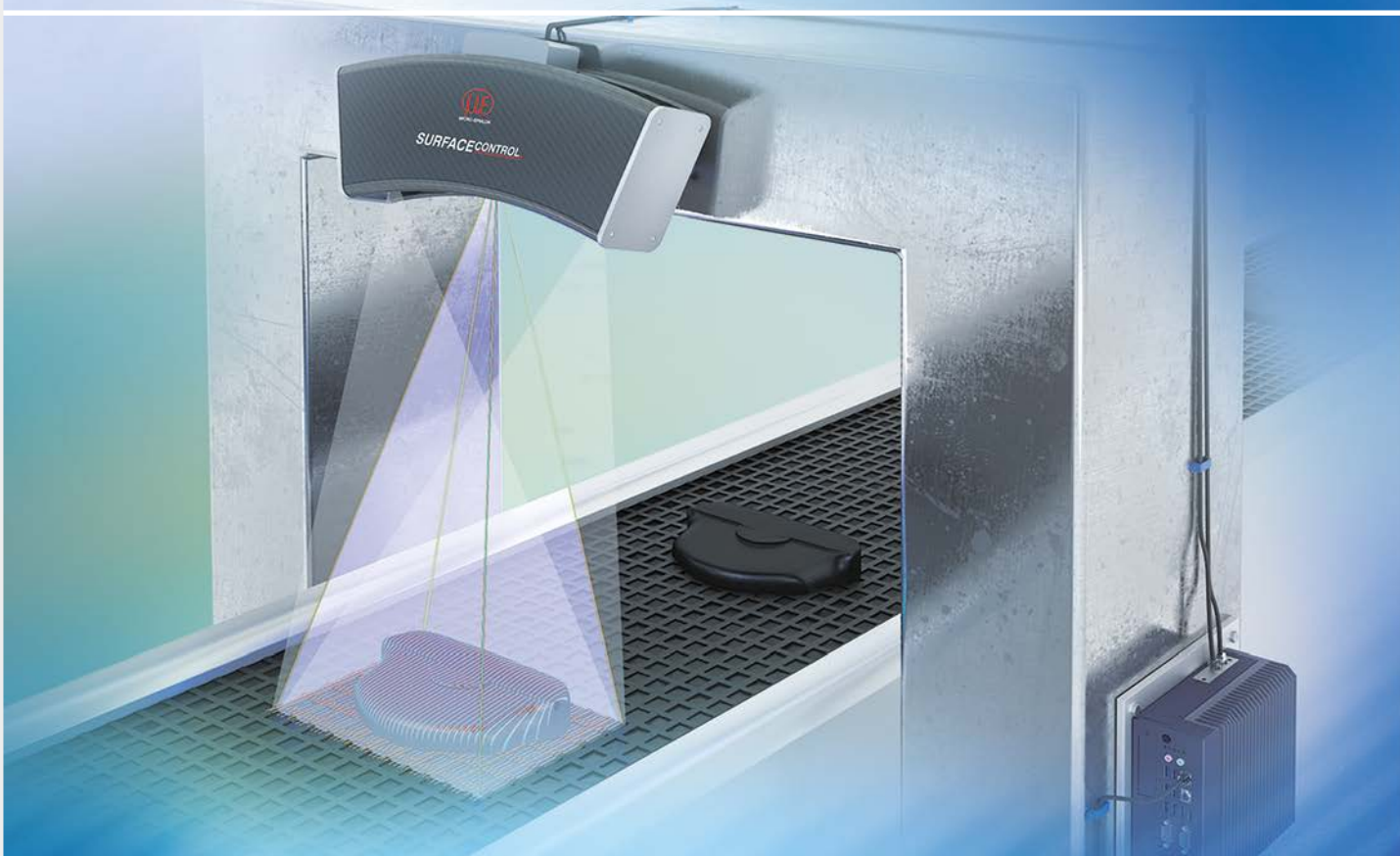

More Precision

surface**CONTROL 3D** 2500 // 3D sensor for geometry, shape and surface inspections





Measuring large objects,
max. 650 x 495 mm

High measuring range depth up to 300 mm

Z-axis repeatability up to 0.5 μm

Acquisition time from 0.5 seconds

Automated inline 3D measurement for
geometry, shape and surface inspections

Real 3D data via latest 3D GigE Vision
standard

3D snapshot sensor for surface inspection of large objects

The surfaceCONTROL 3D sensors are ideally suited to automated inline inspection of geometry, shapes and surfaces on diffuse reflecting surfaces. The 3D snapshot sensors work according to the principle of fringe projection, which allows direct 3D measurement of components. The sensor is characterized by a large measuring field as well as a high measuring range depth with a z-axis repeatability of up to 0.5 μm . Three models cover different measuring fields.

The captured images are first transferred to the external controller where they are processed into 3D data. The SC2500 controller offers fast data output via the Gigabit Ethernet interfaces. The 2D/3D Gateway II supports EtherNet/IP, PROFINET and EtherCAT connections. 3DInspect, DefMap3D and InspectionTools are powerful software tools that enable precise 3D measurements and surface inspection. GigE Vision compatibility also allows easy integration into third-party image processing software. The comprehensive SDK for customer software integration rounds off the software package.

GigE[®]
VISION

C/C++

Microsoft[®]
.NET

Software integration via Micro-Epsilon's SDK

The surfaceCONTROL sensors are equipped with an easy-to-integrate SDK (Software Development Kit). The SDK is based on the GigE Vision and GenICam industry standards including the following function blocks:

- Network configuration and sensor connection
- Comprehensive sensor control
- Control of measurement data transfer (3D data, video images, ...)
- Management of user-defined parameter sets
- C/ C++/ C# library, example programs and documentation

Accessing the sensor via GigE Vision is also possible without SDK if you have a GenICam-compliant software from a third party.

3D inspection of geometry and shape detection of large objects using 3DInspect and 3DView

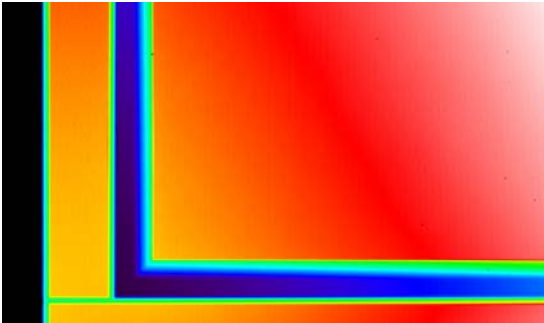

Shape defects on furniture boards

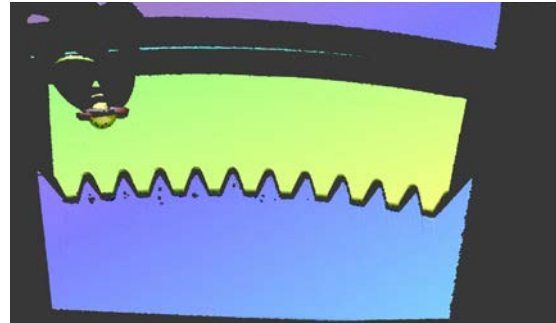

Breakouts of cast part such as e.g. sprocket

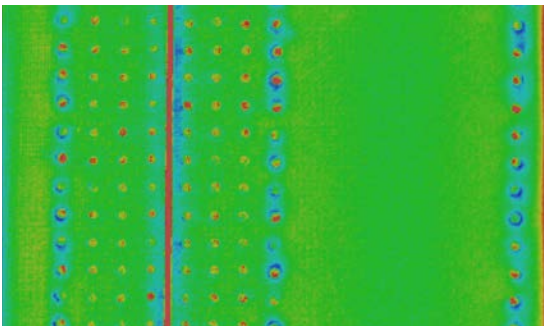

Rivet inspection: deformation, height and position of the rivet

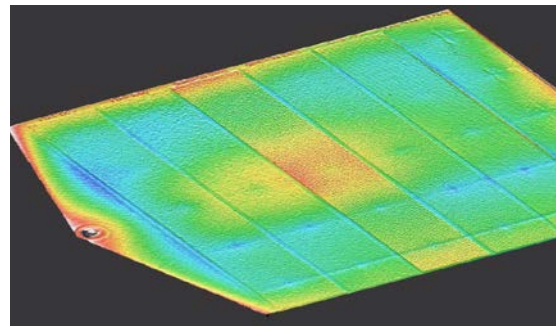

Sink mark on injection molded components

3D surface inspection with surfaceCONTROL DefMap3D and InspectionTools



Exterior plastic parts



Electronic devices



Car body parts



Household appliances / white goods



Interior plastic parts

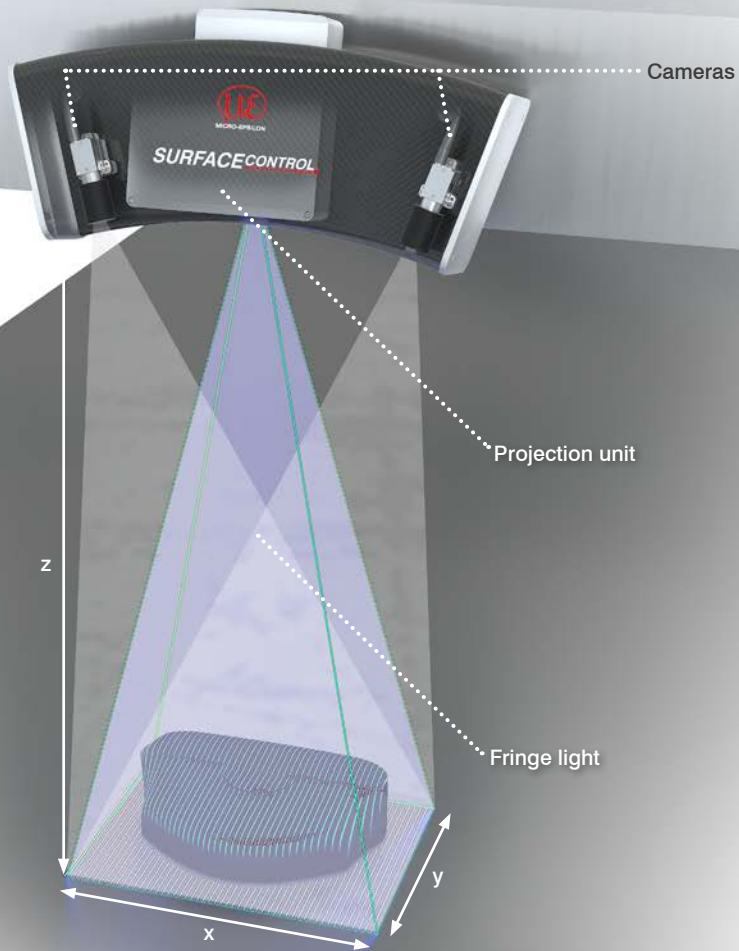

Measuring principle

The surfaceCONTROL 3D 2500 works according to the principle of optical triangulation based on fringe projection. Using a matrix projector, a sequence of patterns is projected onto the test object surface. The light of the patterns diffusely reflected by the test object surface is recorded by two cameras. The three-dimensional surface of the test object is then calculated from the recorded image sequence and the knowledge of the arrangement of the two cameras to each other.

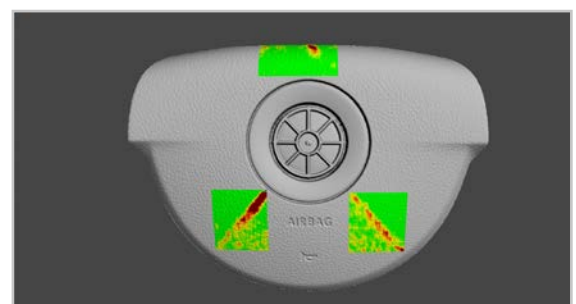
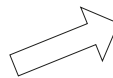

Steering wheel cover in DefMap3D

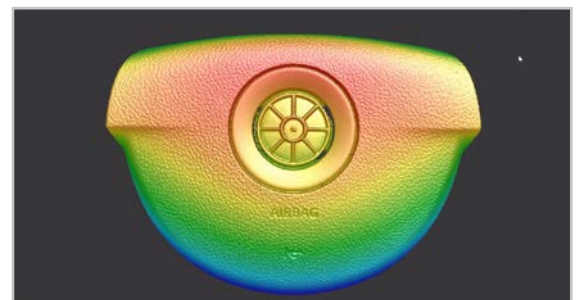
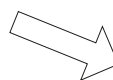

Steering wheel cover in DefMap3D

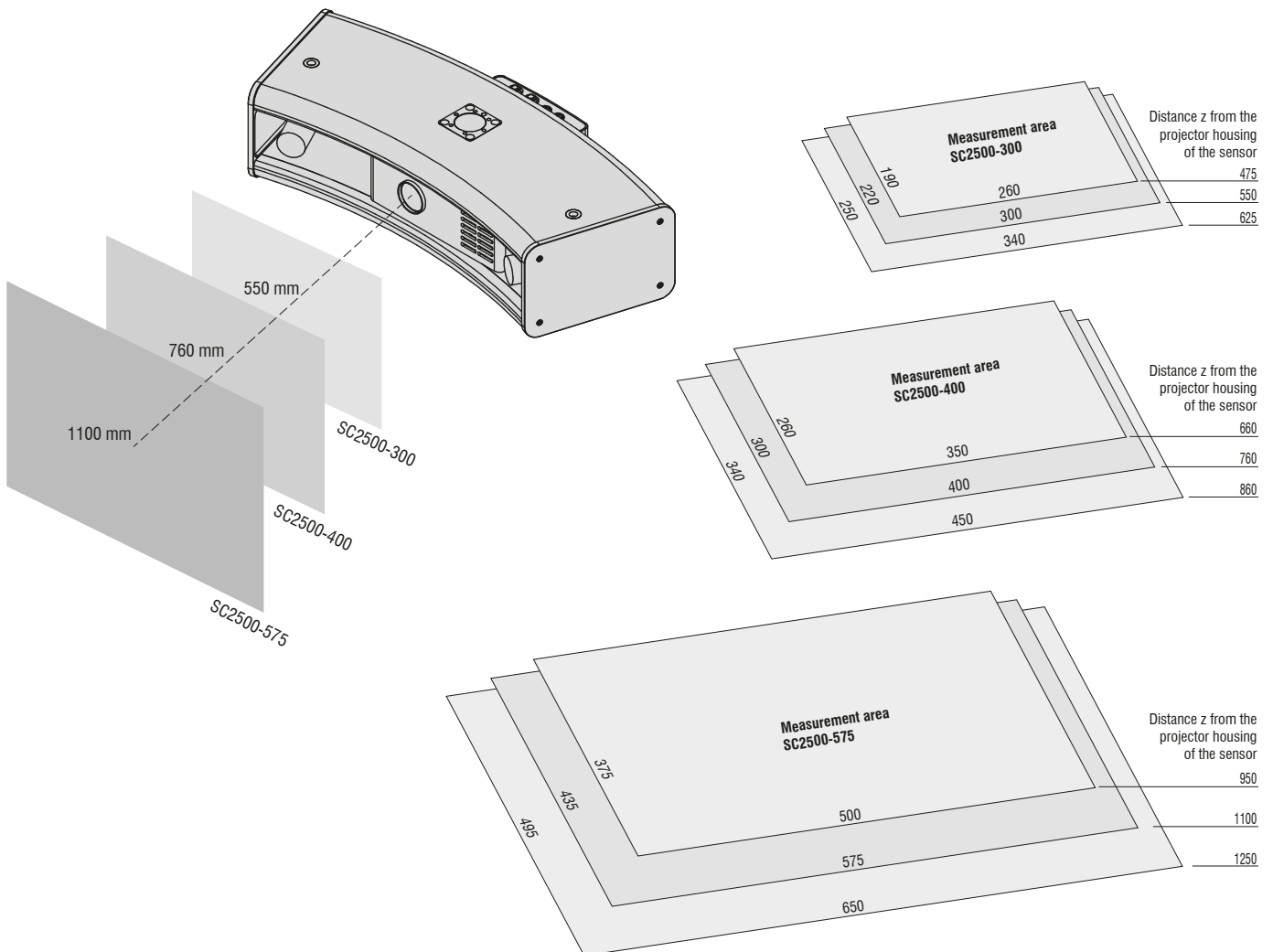
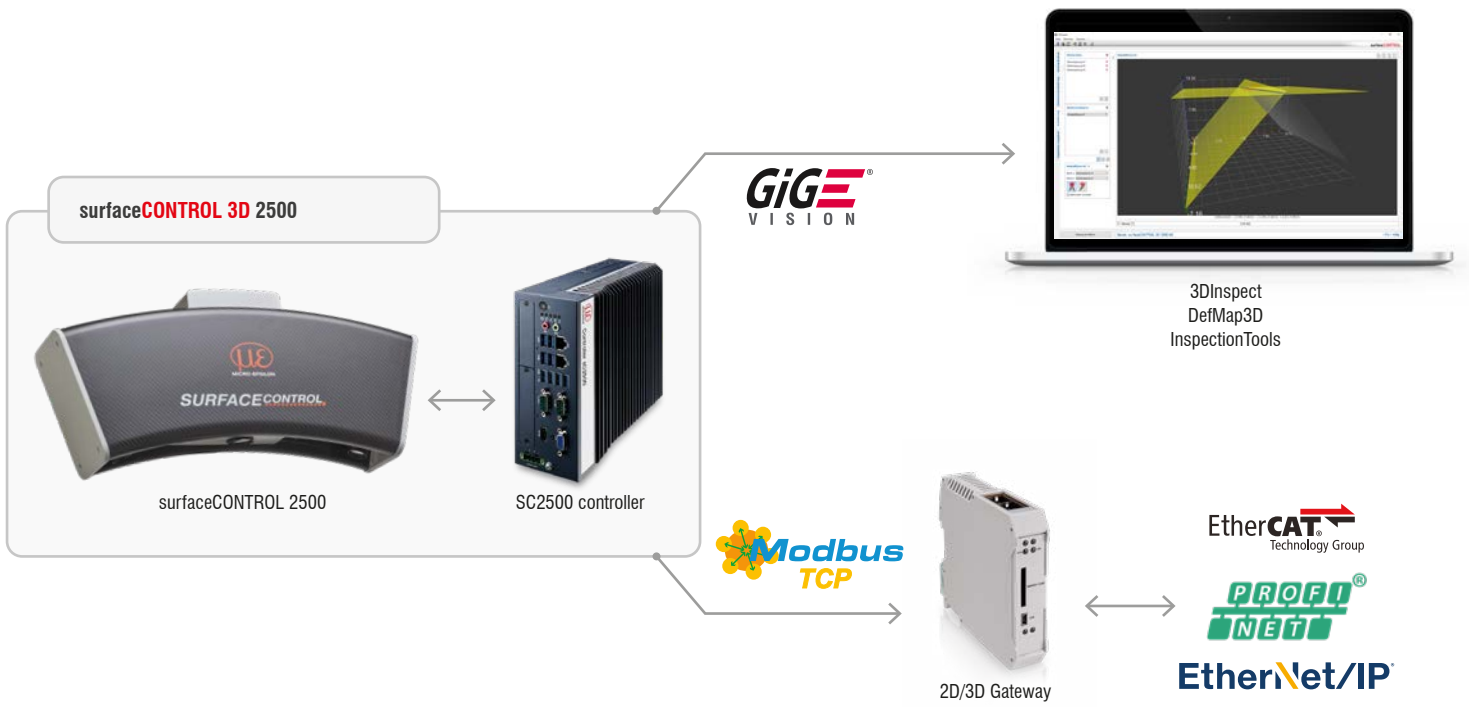

Model	surfaceCONTROL 3D	SC2500-300	SC2510-300	SC2500-400	SC2510-400	SC2500-575	SC2510-575
Measurement area Length (x) * width (y) at distance (z)	Start	260 mm x 190 mm at 475 mm		350 mm x 260 mm at 660 mm		500 mm x 375 mm at 950 mm	
	Mid	300 mm x 220 mm at 550 mm		400 mm x 300 mm at 760 mm		575 mm x 435 mm at 1100 mm	
	End	340 mm x 250 mm at 625 mm		450 mm x 340 mm at 860 mm		650 mm x 495 mm at 1250 mm	
Working distance	z	550 ± 75 mm		760 ± 100 mm		1100 ± 150 mm	
Resolution	x,y	250 μm		300 μm		500 μm	
	z ¹⁾	1.2 μm		3.4 μm		8.5 μm	
Repeatability	Z _(σ) ¹⁾	< 0.5 μm		< 1.2 μm		< 3.0 μm	
Acquisition time ^{2) 3)}				0.5 ... 1 s			
Light source				LED			
Supply voltage				18 VDC ± 33 %			
Max. current consumption				6 ... 12.5 A			
Connection		8-pin M12 socket for Gigabit Ethernet camera 1, connection to controller, 8-pin M12 socket for Gigabit Ethernet camera 2, connection to controller, 4-pin LEMO push-pull plug for sensor control (USB), connection to controller, 2-pin LEMO push-pull plug for supply voltage					
Mounting		Mounting via flange adapter (see accessories)					
Temperature range ⁴⁾	Storage	-10 ... +50 °C, non-condensing					
	Operation	+5 ... +40 °C					
Protection class (DIN EN 60529)		IP40					
Material		Carbon, aluminum, plastic					
Weight		7.0 kg (without controller)					
Control and display elements		2 LEDs on each camera (for device status, power, data transmission)					
Sensor SDK		Micro-Epsilon 3D Sensor-SDK					
3D evaluation software		Micro-Epsilon 3DInspect					
Functional extension		-	3DInspect Automation	-	3DInspect Automation	-	3DInspect Automation
Surface analysis software	(optional)	surfaceCONTROL DefMap3D					

¹⁾ Measured on measuring object with cooperative surface in the center of the measurement area while the EnhancedSNR parameter is enabled and a 3x3 mean value filter is used once at a consistent room temperature of (20 ± 1 °C).

²⁾ Duration that the sensor requires for the image acquisition of the pattern projections (without processing and evaluation time).

³⁾ Applies for exposure times < 25 ms

⁴⁾ According to technical data

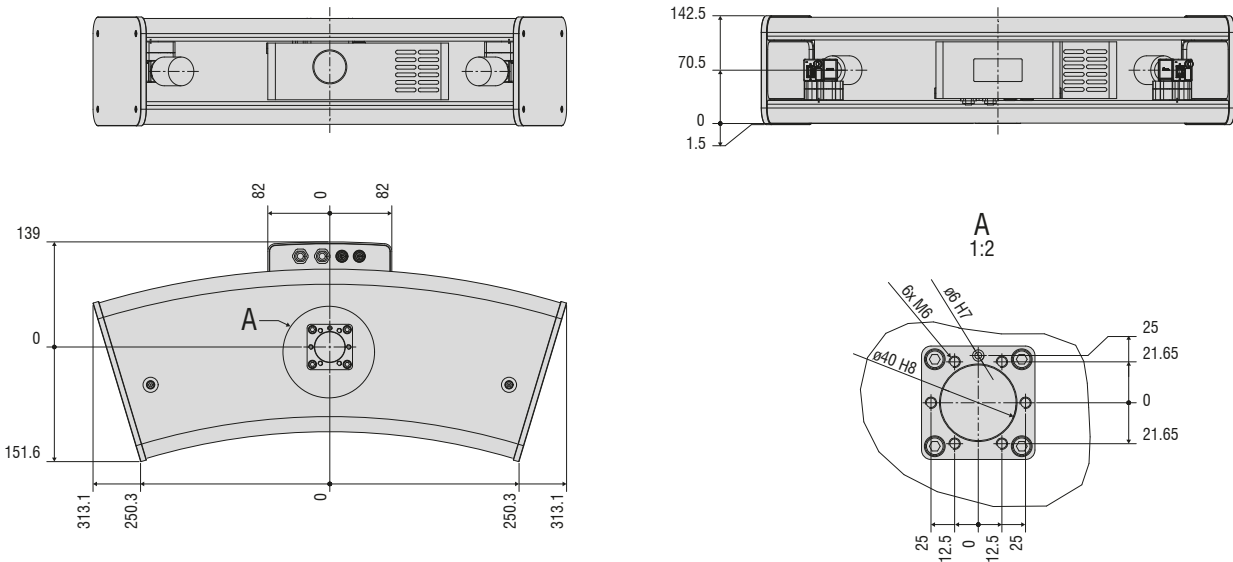

Model	SC2500 controller	
RAM	16 GB	
Supply voltage	9 ... 36 V DC	
Max. current consumption	3 ... 12.4 A	
Digital interfaces	4 x Gigabit Ethernet (GigE Vision / GenICam) / USB 2.0 (sensor control) / PROFINET ²⁾ / EtherCAT ²⁾ / EtherNet/IP ²⁾	
Connection	4-pin supply terminal strip, 4 x Ethernet	
Mounting	Mounting holes, DIN rail mounting kit	
Temperature range	Storage	-40 ... +85 °C
	Operation ¹⁾	-10 ... +60 °C
Shock (DIN EN 60068-2-27)	20 g / 11 ms half-sine	
Vibration (DIN EN 60068-2-6)	3 g / 5 ... 500 Hz	
Protection class	IP40	
Material	Metal housing	
Weight	2.8 kg	
Control and display elements	2 LEDs for storage and power; 4 LEDs for COM1 TX/RX and COM2 TX/RX 1 power on/off switch	

1) Max. permissible operating temperature with 0.7 m/s air blow

³⁾ Connection via 2D/3D Gateway interface module

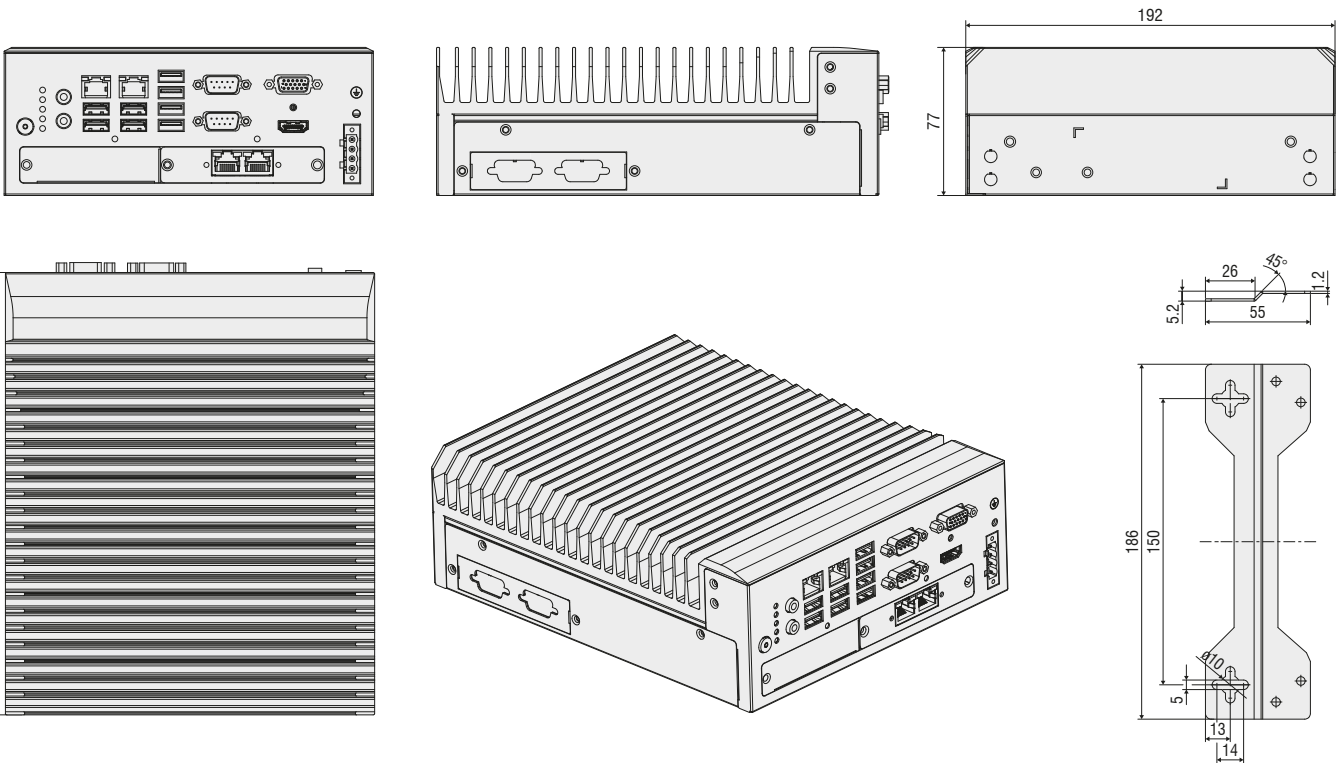

Please note: Optionally also with DIN rail mounting kit

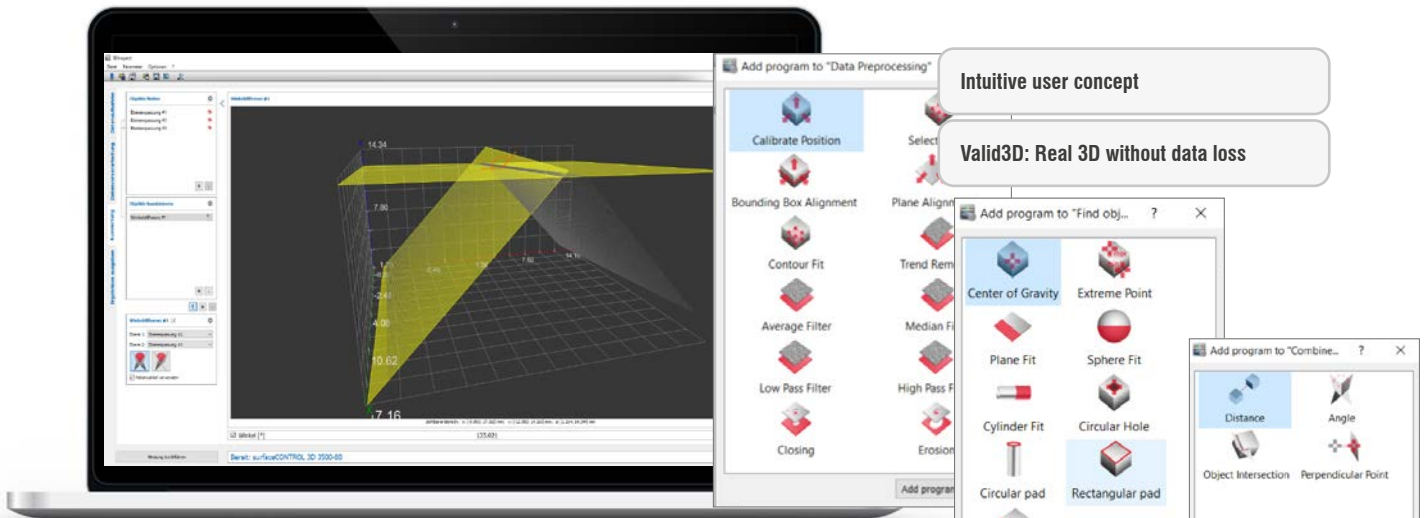

3DInspect software for 3D measurement and inspection tasks

The 3DInspect software is a powerful tool for sensor parameter set up and industrial measurement tasks. This software receives the measurement data from the sensor via Ethernet and provides the data in three-dimensional form. This 3D data is further processed, evaluated, assessed and logged with 3DInspect measuring programs on the PC. If necessary, the result is transmitted via Ethernet to a control unit. Furthermore, the software enables the storage of 3D data in different formats. The 3DInspect software is included. For connection to an automation interface, the 3DInspect Automation function extension is enabled with use of the SC2510 sensors, which also includes comprehensive data logging.

Intuitive user concept

Valid3D: Real 3D without data loss

The pre-defined measuring software programs can be divided into the categories "Data preprocessing", "Find objects" as well as in "Combine objects".

Valid3D: Real 3D without data loss

Measuring object

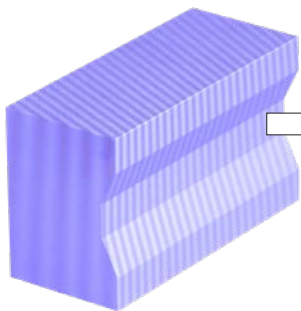

Point cloud

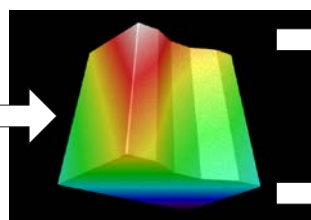

Point cloud after turn



3DInspect with Valid3D

- Real 3D image of test object without data loss
- Analysis and evaluation of complete test object

Common 3D software

- Algorithms based on 2.5D
- Only one z-coordinate per x/y coordinate possible
- Data loss during data processing

3D-View software for 3D visualization

The 3D-View software offers a convenient user interface for surfaceCONTROL sensors. This user-friendly software enables quick commissioning and evaluation of the sensor. It offers set up and optimization of parameters and ensures the correct positioning of the measuring object and sensor. The software can also be used to start data acquisition. It visualizes the 3D data obtained and exports it in different file formats (ASCII, CSV, STL, PLY) for further processing.

The 3D-View software is particularly helpful for system integrators as it provides important information. They can access all GenICam parameters, which considerably simplifies the integration of the software. For inline applications, the display of the measurement duration allows conclusions to be drawn about the cycle time.

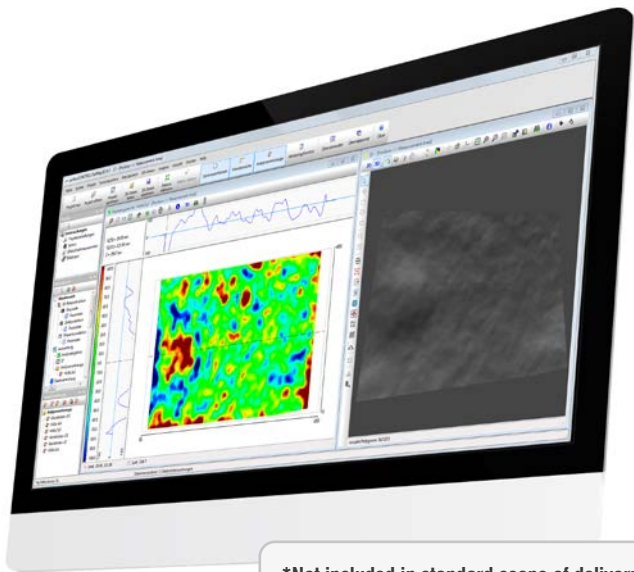

*Not included in standard scope of delivery

surfaceCONTROL DefMap3D for individual surface analysis*

surfaceCONTROL DefMap3D is a comprehensive software solution for the detection and analysis of surface defects. It includes all components and processes required for set up, configuration and evaluation of inspection tasks.

The wide range of features equally supports the analysis of individual parts, the measurement of small series as well as the robot-supported inspection of several measuring fields. Sensor control, calculation of the 3D point cloud and defect detection can be automated using macro commands. As part of the surface analysis, the software provides several methods of detecting and objectively evaluating shape errors within the surface data. The targeted use of different filter types can reduce the effects of surface structures (e.g. graining). A report containing the inspection results is generated. surfaceCONTROL DefMap3D is available in different versions whose scope of performance is oriented towards different measurement tasks.

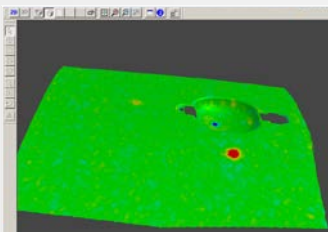

Digital Master

Detects 3D data of faultless components and computes the parameter via permissible surface shapes for storage in an associative memory. Behind this is a neuronal network, which is trained with the data. For each test part, an individual digital master is processed from this as a reference for the test.

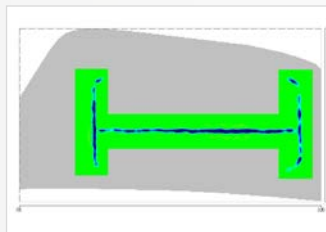

Digital Stone

With the 3D data, you can determine the two highest points (point of support) along a line segment in a given direction. Afterwards the gaps between this line and the 3D data are calculated.

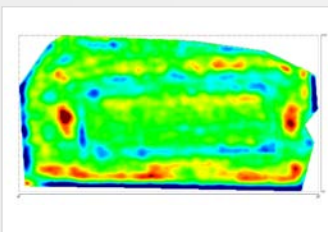

Digital Shape

The 3D data of the surface is described using polynomials. Depending on their degree, the polynomials have the ability to adapt the shape of the surface like an envelope. The 3D data is compared against the calculated envelope and possible deviations in the surface are identified as defects.

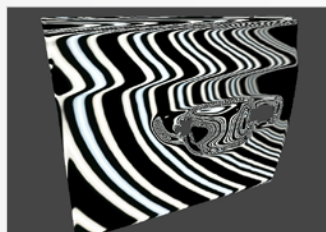

Digital Light Tunnel

The captured 3D data is given defined properties (color, gloss) and optionally reflected on the screen with a diffuse light or a light bar. This is how even the smallest defects become visible and can be assessed visually.

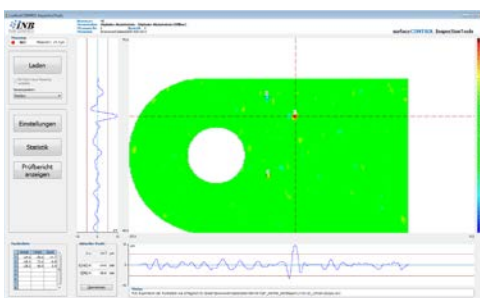

surfaceCONTROL InspectionTools for automated inspection

The software is based on a modular concept that accurately reflects the required amount of tools for each inspection task. The software uses an interface to communicate with master control devices, for example to start measurements or output OK/NOK decisions. The lean software provides precise functionality and ensures reliable operation of the measuring system. A user management feature defines different access levels. The captured data is recorded to ensure long-term quality monitoring and traceability of results.

Inspection of car body components

One of the main application fields of the surface inspection systems is the identification and analysis of deformations and discontinuity in automotive body shell parts. Because of the different fouling, material tolerances or variations in the process, unwanted shape defects such as pimples, bumps, dents and neckings may appear during pressing.

The surfaceCONTROL 3D 2500 sensor inspects the surface of car body components in just a few seconds, and recognizes and assesses local defects thanks to comprehensive software.

The determined values can be used for an automatic OK/NOK-decision.



Driver door

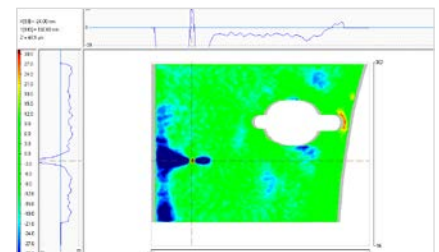

Result of digital stone

Inspection of exterior plastic parts

In the automotive industry, injection molded plastic parts, such as fenders, fuel filler flaps or door panels, as well as parts made of composite materials (SMC), such as tailgates or spoilers, are increasingly being used in the outer skin.

The surfaceCONTROL systems reliably recognize and evaluate the shape deviations on these components and help to reduce the quality costs and to avoid waste or rework.

Fields of application:

- Development up to the first prototype
- Tool and die manufacturing
- Series production start-up
- Series supervision (sample checks or 100% inspection)

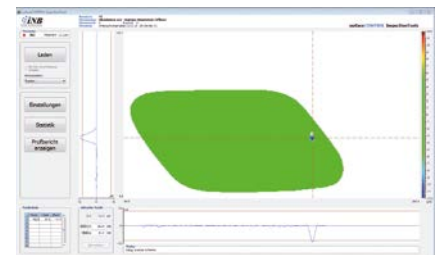

Result of digital stone on fuel filler flap

Inspection of interior plastic parts

The surfaceCONTROL 3D 2500 is used in the quality assurance of interior plastic parts. This involves checking compliance with the tight manufacturing tolerances of interior components after assembly. One key aspect is the control panel and dashboard, which can always be seen by the front seat passengers.

In the process, surfaceCONTROL 3D 2500 checks visual requirements, e.g. in the area of the intended "weak point" of the passenger airbag in the dashboard. The sensor reliably detects undesirable sink marks and surface waviness caused by ventilation ducts or glove compartments.

The surfaceCONTROL 3D 2500 measuring system enables fast, objective evaluations to be made of the characteristics of any shape deviations, both on grained and smooth surfaces.

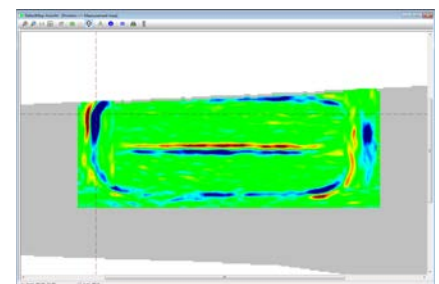

Result of digital stone
Objective assessment of airbag profile



Full-surface back projection of the inspection result







surfaceCONTROL Robotic

When mounting the sensor to a robot, the system can be quickly and easily adapted to different measurement tasks. The sensor cable with robust fiber optics enables all six degrees of freedom for the robot. According to the requirements, a robot with a certain dimension can be chosen.

If the component is positioned on a rotary table as a seventh axis, it can be turned towards the sensor reducing the required outreach of the robot. Due to surfaceCONTROL Robotic large components can undergo a complete inspection with only one sensor.



surfaceCONTROL 3D 2500 Accessories

Connection cables		Installation of sensor system		Accessories
<p>Cable harness/5 m/standard for surfaceCONTROL Art. no. 6901004</p> 				<p>Column stand set Art. no. 2961010</p> 
<p>Table power pack for controller Advantech ADP Art. no. 2420111</p> 				<p>(stand + ground spreader + bag + head + adapter)</p> <p>Column stand Art. no. 2961002</p> 
<p>2D/3D Gateway Art. no. 6414142</p> 	<p>Ethernet patch cable Art. no. 2901795 (2 m) 2901797 (5 m) 2901798 (10 m)</p> 	<p>Mounting adapter 47° Art. no. 3005619</p> 	<p>Transport case Art. no. 0254053</p> 	
		<p>Mounting adapter X95/ dovetail Art. no. 3005422</p> 		

Innovative 3D Technologies from Micro-Epsilon

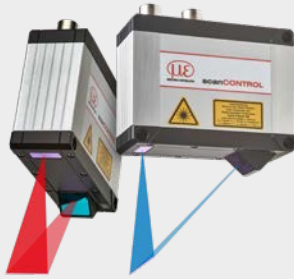

scanCONTROL

- Precise laser line scanners for 3D point clouds
- Red laser & patented Blue Laser Technology
- Up to 2048 points per profile
- Measuring rates up to 10,000 kHz
- Numerous measuring ranges

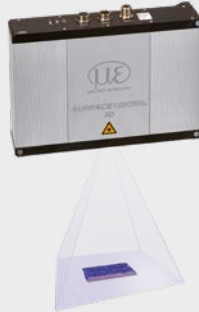

surfaceCONTROL 3D 3500/3200

- Highest z-axis repeatability up to 0.4 μm
- Automated inline 3D measurement for geometry, shape and surface inspections
- Up to 2.2 million 3D points / second
- Fully integrated industrial sensor (IP67) with passive cooling
- 3D data via latest 3D GigE Vision standard
- Comprehensive SDK & evaluation software
- New 3D GigE Vision / GenICam standard for easy integration into all common 3D image processing packages



reflectCONTROL Sensor

- Measurement of shiny, flat components
- Fast, full-surface inspection
- High-precision measurements, flatness deviation in the submicron range
- Large measuring field